

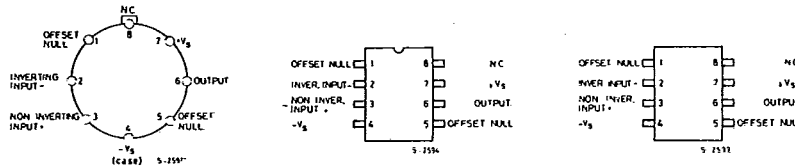

7929225 S G S SEMICONDUCTOR CORP

CONNECTION DIAGRAMS AND ORDERING NUMBERS



Type	TO-99	Minidip	SO-8
LS 141	LS 141 TB	—	—
LS 141A	LS 141 ATB	—	—
LS 141C	LS 141 CTB	LS 141 CB	LS 141 CM
LS 8141	—	—	LS 8141M
LS 8141A	—	—	LS 8141 AM
LS 8141C	—	—	LS 8141 CM

SCHEMATIC DIAGRAM

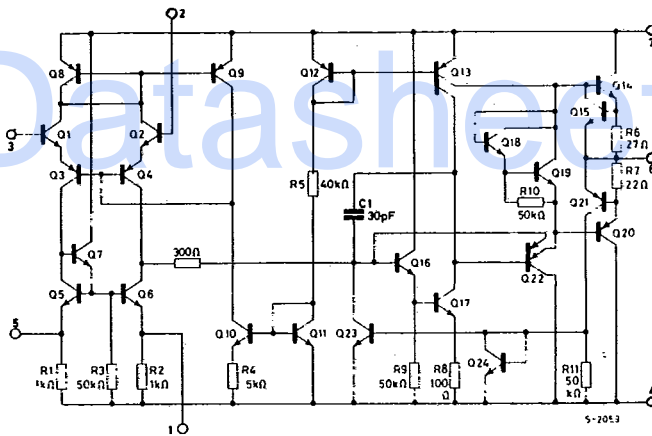

THERMAL DATA

	TO-99	Minidip	SO-8
$R_{th j-amb}$ Thermal resistance junction ambient	max 155 °C/W	120 °C/W	200* °C/W

* Measured with the device mounted on a ceramic substrate (25 x 16 x 0.6 mm)

0259

E-02

221



7929225 S G S SEMICONDUCTOR CORP

ELECTRICAL CHARACTERISTICS (see note)

Parameter	Test conditions	LS 141			LS 141A			LS 141C			Unit
		Min.	Typ.	Max.	Min.	Typ.	Max.	Min.	Typ.	Max.	
V_{os} Input offset voltage	$T_{amb} = 25^{\circ}\text{C}$ $R_g < 10\text{ k}\Omega$ $R_g < 50\ \Omega$		1	5		0.8	3		2	6	mV mV
	$T_{amb} = T_{min}$ to T_{max} $R_g < 10\text{ k}\Omega$ $R_g < 50\ \Omega$			6			4			7.5	mV mV
ΔV_{os} Input offset voltage adjust. range	$V_s = \pm 20\text{V}$ $V_s = \pm 15\text{V}$ $T_{amb} = 25^{\circ}\text{C}$		± 15		± 10				± 15		mV mV
							15				$\frac{\mu\text{V}}{^{\circ}\text{C}}$
I_{os} Input offset current	$T_{amb} = 25^{\circ}\text{C}$ $T_{amb} = T_{min}$ to T_{max}		20 85	200 500		3 30	70		20 200	300	nA nA
							0.5				$\frac{\text{nA}}{^{\circ}\text{C}}$
I_b Input bias current	$T_{amb} = 25^{\circ}\text{C}$ $T_{amb} = T_{min}$ to T_{max}		80	500 1.5		30 80	0.21		80	500 0.8	nA μA
											$\text{M}\Omega$ $\text{M}\Omega$
R_i Input resistance	$T_{amb} = 25^{\circ}\text{C}$ $T_{amb} = T_{min}$ to T_{max}	0.3	2		1 0.5	6		0.3	2		$\text{M}\Omega$ $\text{M}\Omega$
											V
V_i Input voltage range	$T_{amb} = T_{min}$ to T_{max}	± 12	± 13		± 12	± 13		± 12	± 13		V
G_v Large signal voltage gain	$T_{amb} = 25^{\circ}\text{C}$ $R_L \geq 2\text{ k}\Omega$ $V_s = \pm 15\text{V}$ $V_o = \pm 10\text{V}$	94	106		94			86	106		dB
	$T_{amb} = T_{min}$ to T_{max} $R_L \geq 2\text{ k}\Omega$ $V_s = \pm 15\text{V}$ $V_o = \pm 10\text{V}$ $V_s = \pm 5\text{V}$ $V_o = \pm 2\text{V}$	88			90 80			84			dB
V_o Output voltage swing	$V_s = \pm 15\text{V}$ $R_L \geq 10\text{ k}\Omega$ $R_L \geq 2\text{ k}\Omega$	± 12 ± 10	± 14 ± 13		± 12 ± 10	± 14 ± 13		± 12 ± 10	± 14 ± 13		V V
I_{sc} Output short circuit current	$T_{amb} = 25^{\circ}\text{C}$ $T_{amb} = T_{min}$ to T_{max}		25		10 10	25	35 40		25		mA mA
CMR Common mode rejection	$V_s = \pm 20\text{V}$ $R_g \leq 10\text{ k}\Omega$ $V_{CM} = \pm 12\text{V}$	70	90		80	95		70	90		dB
SVR Supply voltage rejection	$R_g \leq 50\ \Omega$ $V_s = \pm 5$ to $\pm 20\text{V}$ $R_g \leq 10\text{ k}\Omega$ $V_s = \pm 5$ to $\pm 15\text{V}$	77	96		86	96		77	96		dB dB



ELECTRICAL CHARACTERISTICS (continued)

Parameter	Test conditions	LS 141			LS 141A			LS 141C			Unit
		Min.	Typ.	Max.	Min.	Typ.	Max.	Min.	Typ.	Max.	
Transient respon. (unity gain) Rise time Overshoot	$T_{amb} = 25^{\circ}C$		0.3 5			0.25 6	0.8 20		0.3 5		μs %
B Bandwidth	$T_{amb} = 25^{\circ}C$				0.437	1.5					MHz
SR Slew rate	$T_{amb} = 25^{\circ}C$		0.5		0.3	0.7			0.5		V/ μs
I _s Supply current	$T_{amb} = 25^{\circ}C$		1.7	2.8					1.7	2.8	mA
P _{tot} Power consumption	$T_{amb} = 25^{\circ}C$ $V_s = \pm 20V$ $V_s = \pm 15V$		50	85		80	150		50	85	mW mW
	$V_s = \pm 20V$ $T_{amb} = T_{min}$ $T_{amb} = T_{max}$						165 135				mW mW
	$V_s = \pm 15V$ $T_{amb} = T_{min}$ $T_{amb} = T_{max}$		60 45	100 75							mW mW

Note: These specifications, unless otherwise specified, apply for $V_s = \pm 15V$ and $T_{amb} = -55$ to $125^{\circ}C$ for LS 141 and LS 141A. For the LS 141C these specifications apply for $T_{amb} = 0$ to $70^{\circ}C$

Fig. 1 - Open loop voltage gain vs. supply voltage

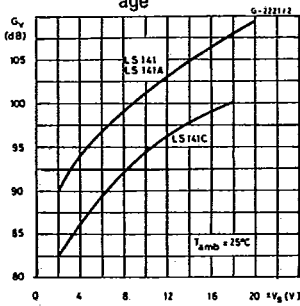

Fig. 2 - Output voltage swing vs. supply voltage

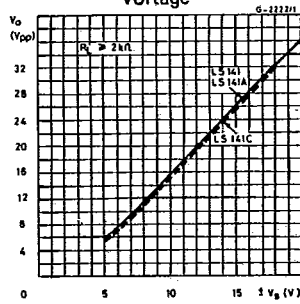
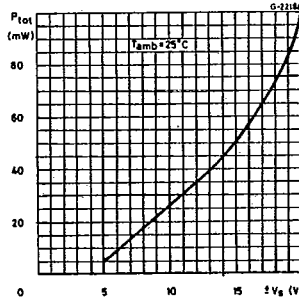

Fig. 3 - Power consumption vs. supply voltage





S G S-THOMSON

Fig. 4 - Open loop voltage gain vs. frequency

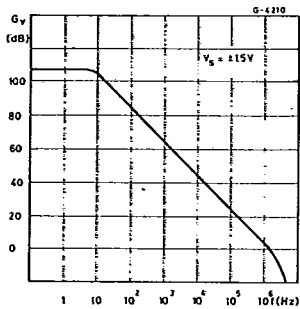

Fig. 5 - Open loop phase response vs. frequency

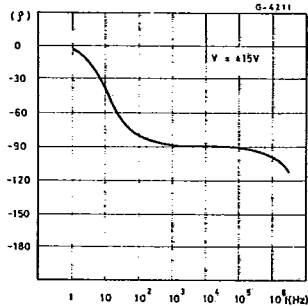

Fig. 6 - Input offset current vs. supply voltage (for LS 141 and LS 141C)

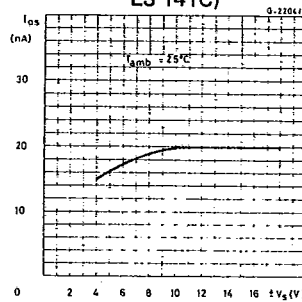

Fig. 7 - Input resistance and capacitance vs. frequency (for LS 141 and LS 141C)

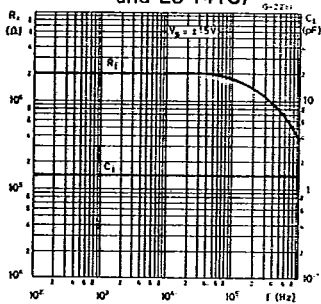

Fig. 8 - Output resistance vs. frequency

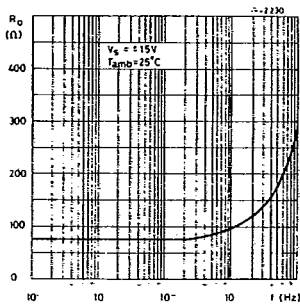

Fig. 9 - Output voltage swing vs. load resistance

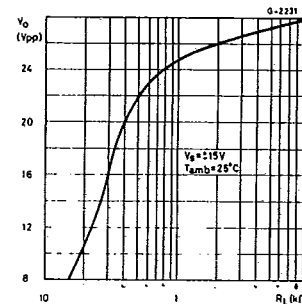

Fig. 10 - Output voltage swing vs. frequency

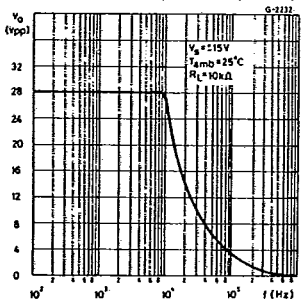

Fig. 11 - Input noise voltage vs. frequency

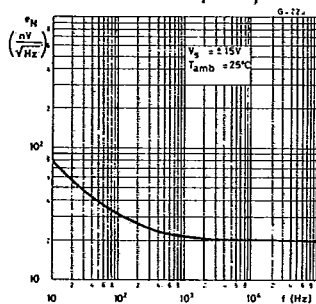
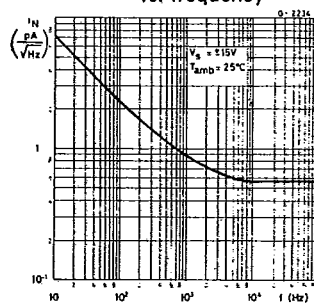
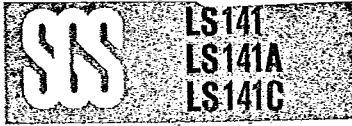

Fig. 12 - Input noise current vs. frequency





7929225 S G S SEMICONDUCTOR CORP

Fig. 13 - Transient response

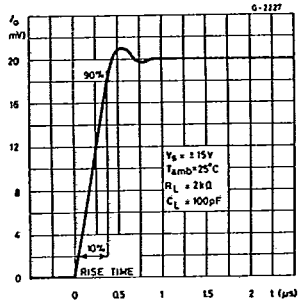

Fig. 14 - Common mode rejection ratio vs. frequency

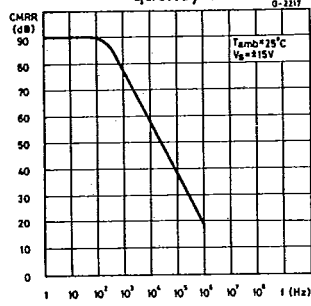
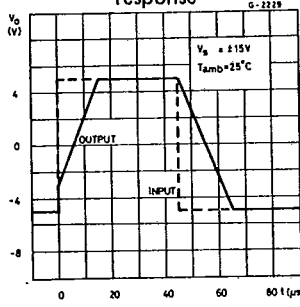

Fig. 15 - Voltage follower large signal pulse response



Typical performance curves for LS 141 and LS 141A

Fig. 16 - Input bias current vs. ambient temperature

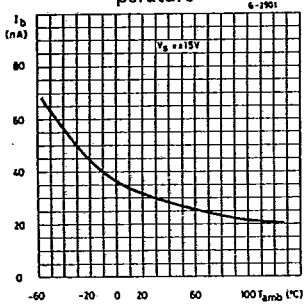

Fig. 17 - Input resistance vs. ambient temperature

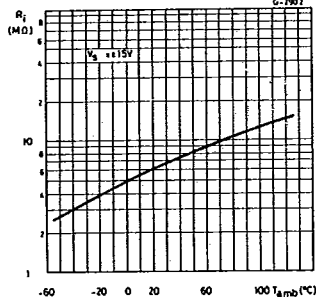

Fig. 18 - Input offset current vs. ambient temperature

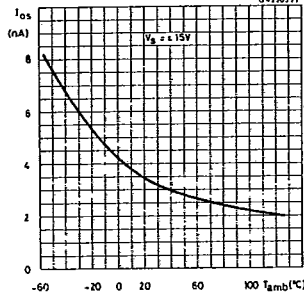

Fig. 19 - Output short-circuit current vs. ambient temperature

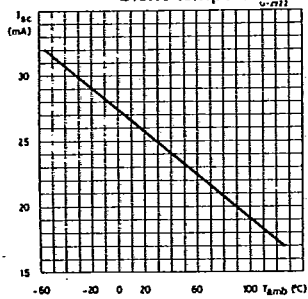

Fig. 20 - Power consumption vs. ambient temperature

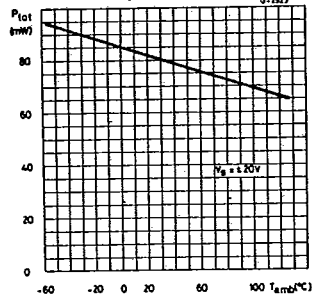
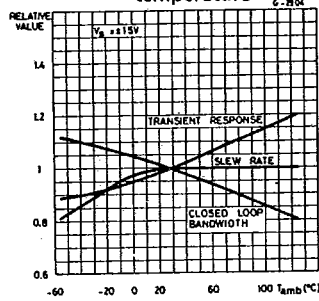

Fig. 21 - Frequency characteristics vs. ambient temperature





7929225 S G S SEMICONDUCTOR CORP

Typical performance curves for LS 141C

Fig. 22 - Input bias current vs. ambient temperature

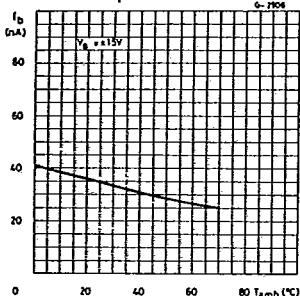

Fig. 23 - Input resistance vs. ambient temperature

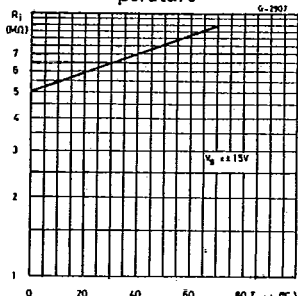

Fig. 24 - Input offset current vs. ambient temperature

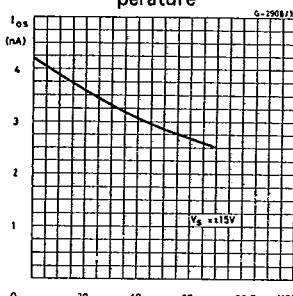

Fig. 25 - Output short circuit current vs. ambient temperature

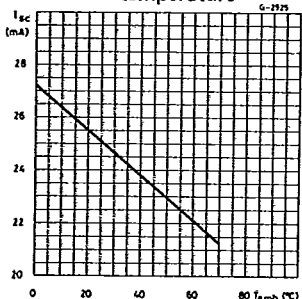

Fig. 26 - Power consumption vs. ambient temperature

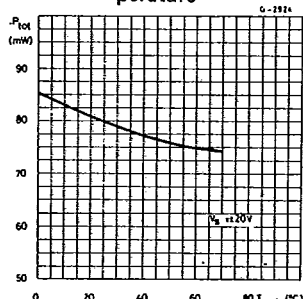
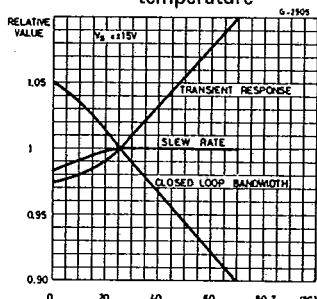

Fig. 27 - Frequency characteristics vs. ambient temperature



TYPICAL APPLICATIONS

Fig. 28 - Clipping amplifier

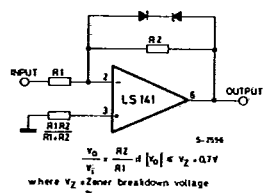

Fig. 29 - Simple integrator

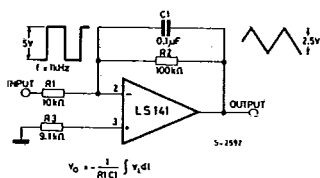
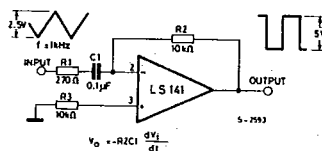

Fig. 30 - Simple differentiator





LINEAR INTEGRATED CIRCUITS

7929225 S G S SEMICONDUCTOR CORP

OPERATIONAL AMPLIFIERS

- SHORT-CIRCUIT PROTECTION
- OFFSET VOLTAGE NULL CAPABILITY
- LARGE COMMON MODE AND DIFFERENTIAL VOLTAGE RANGE
- NO LATCH-UP
- SLEW-RATE = $5.5V/\mu s$ ($G_v = 10$, $C_C = 3.5 pF$)

The LS 148 series consists of general purpose operational amplifiers, intended for a wide range of analog applications where tailoring of frequency characteristics is desirable. High common mode voltage range and absence of "Latch-up" tendencies make the LS 148 series ideal for use as a voltage follower. The high gain and wide range of operating voltage provide superior performance in integrators, summing amplifiers and general feedback applications. Unity gain frequency compensation is achieved by means of a single 30 pF capacitor. The LS 148 series is available with hermetic gold chip (8000 series). This is particularly suitable for professional and telecom applications, wherever very high MTBF are required.

ABSOLUTE MAXIMUM RATINGS		TO-99	Minidip	μ package
V_s	Supply voltage		$\pm 22V$	
V_i (1)	Input voltage		$\pm 15V$	
ΔV_i	Differential input voltage		$\pm 30V$	
T_{op}	Operating temperature for LS 148/LS 148A for LS 148C		-55 to 125 °C 0 to 70 °C indefinite	
P_{tot}	Output short circuit duration (2)	520 mW	665 mW	400 mW
T_{stg}	Power dissipation at $T_{amb} = 70^\circ C$ Storage temperature	-65 to 150 °C	-55 to 150 °C	-55 to 150 °C

- 1) For supply voltage less than $\pm 15V$, input voltage is equal to the supply voltage
- 2) The short circuit duration is limited by thermal dissipation.

MECHANICAL DATA

Dimensions in mm

