

LM431A/LM431B/LM431C

Programmable Shunt Regulator

Features

- Programmable Output Voltage to 36 Volts
- Low Dynamic Output Impedance 0.20 Typical
- Sink Current Capability of 1.0 to 100mA
- Equivalent Full-range Temperature Coefficient of 50ppm/
°C Typical
- Temperature Compensated for Operation Over Full Rated
Operating Temperature Range
- Low Output Noise Voltage
- Fast Turn-on Response

Description

The LM431A/LM431B/LM431C are three terminal output adjustable regulators with thermal stability over operating temperature range. The output voltage can be set any value between V_{REF} (approximately 2.5 volts) and 36 volts with two external resistors. These devices have a typical dynamic output impedance of 0.2Ω . Active output circuit provides a sharp turn-on characteristic, making these devices excellent replacement for Zener Diodes in many applications.

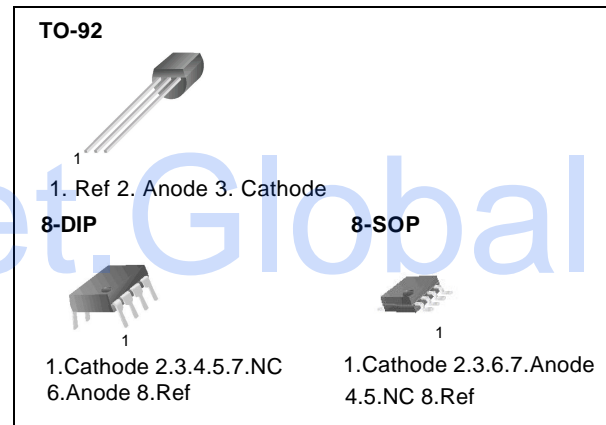

Internal Block Diagram

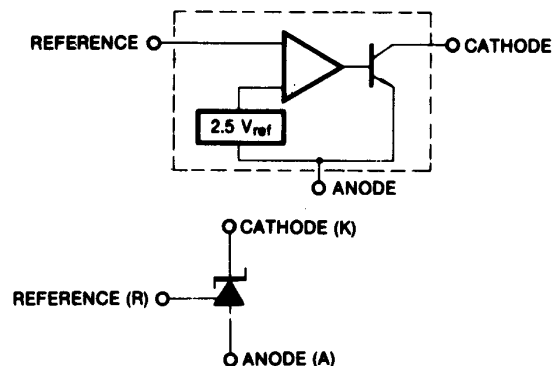

Absolute Maximum Ratings

(Operating temperature range applies unless otherwise specified.)

Parameter	Symbol	Value	Unit
Cathode Voltage	V _{KA}	37	V
Cathode current Range (Continuous)	I _{KA}	-100 ~ +150	mA
Reference Input Current Range	I _{REF}	0.05 ~ +10	mA
Power Dissipation M, Z Suffix Package N Suffix Package	PD	770 1000	mW
Operating Temperature Range			
LM431xC	T _{OPR}	-25 ~ +85	°C
LM431xI		-40 ~ +85	°C
Storage Temperature Range	T _{STG}	-65 ~ +150	°C

Recommended Operating Conditions

Parameter	Symbol	Min	Typ	Max	Unit
Cathode Voltage	V _{KA}	V _{REF}	-	36	V
Cathode Current	I _{KA}	1.0	-	100	mA

Electrical Characteristics

(T_A = +25°C, unless otherwise specified)

Parameter	Symbol	Conditions	LM431A			LM431B			LM431C			Unit		
			Min.	Typ.	Max.	Min.	Typ.	Max.	Min.	Typ.	Max.			
Reference Input Voltage	V _{REF}	V _{KA} =V _{REF} , I _{KA} =10mA	2.450	2.500	2.550	2.470	2.495	2.520	2.482	2.495	2.508	V		
Deviation of Reference Input Voltage Over-Temperature	$\frac{D_{REF}}{DT}$	V _{KA} =V _{REF} , I _{KA} =10mA T _{MIN} ≤ T _A ≤ T _{MAX}	-	4.5	17	-	4.5	17	-	4.5	17	mV		
Ratio of Change in Reference Input Voltage to the Change in Cathode Voltage	$\frac{D_{REF}}{D_{KA}}$	I _{KA} = 10mA	$\frac{D_{KA}=10V-V_{REF}}$		-	-1.0	-2.7	-	-1.0	-2.7	-	-1.0	-2.7	mV/V
			$\frac{D_{KA}=36V-10V}$		-	-0.5	-2.0	-	-0.5	-2.0	-	-0.5	-2.0	
Reference Input Current	I _{REF}	I _{KA} =10mA, R ₁ =10KΩ, R ₂ =∞	-	1.5	4	-	1.5	4	-	1.5	4	μA		
Deviation of Reference Input Current Over Full Temperature Range	$\frac{D_{REF}}{DT}$	I _{KA} =10mA, R ₁ =10KΩ, R ₂ =∞ T _A = Full Range	-	0.4	1.2	-	0.4	1.2	-	0.4	1.2	μA		
Minimum Cathode Current for Regulation	I _{KA(MIN)}	V _{KA} =V _{REF}	-	0.45	1.0	-	0.45	1.0	-	0.45	1.0	mA		
Off - Stage Cathode Current	I _{KA(OFF)}	V _{KA} =36V, V _{REF} =0	-	0.05	1.0	-	0.05	1.0	-	0.05	1.0	μA		
Dynamic Impedance	Z _{KA}	V _{KA} =V _{REF} , I _{KA} =1 to 100mA f ≥ 1.0KHz	-	0.15	0.5	-	0.15	0.5	-	0.15	0.5	Ω		

Note1

- LM431XC : T_{MIN}= -25 °C, T_{MAX}= +85 °C
- LM431XI : T_{MIN}= -40 °C, T_{MAX}= +85 °C

Test Circuits

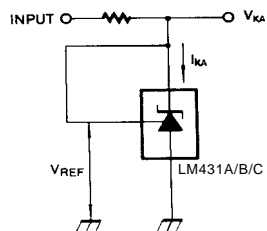

Figure 1. Test Circuit for $V_{KA} = V_{REF}$

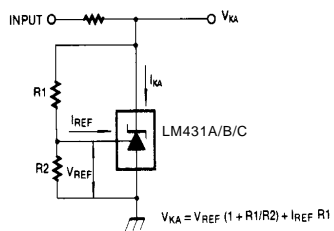

Figure 2. Test Circuit for $V_{KA} = 3V_{REF}$

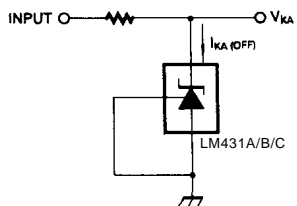

Figure 3. Test Circuit for $I_{KA(OFF)}$

Typical Performance Characteristics

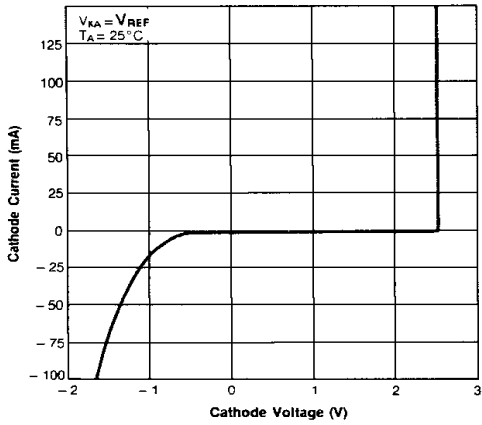

Figure 4. Cathode Current vs. Cathode Voltage

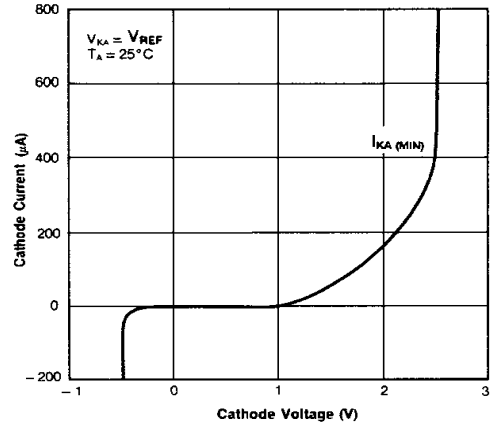

Figure 5. Cathode Current vs. Cathode Voltage

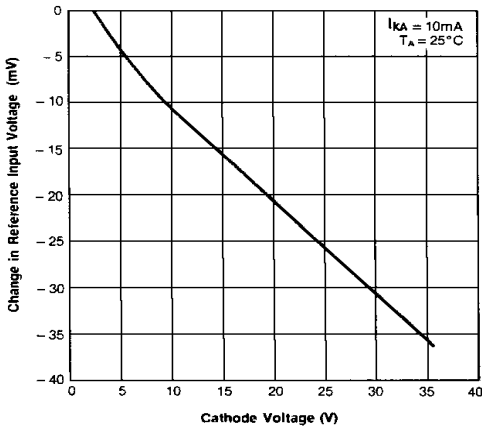

Figure 6. Change In Reference Input Voltage vs. Cathode Voltage

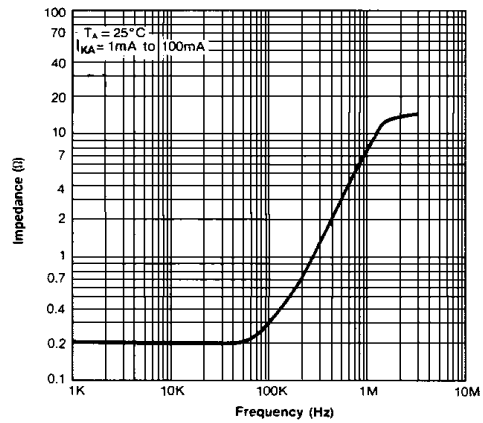

Figure 7. Dynamic Impedance Frequency

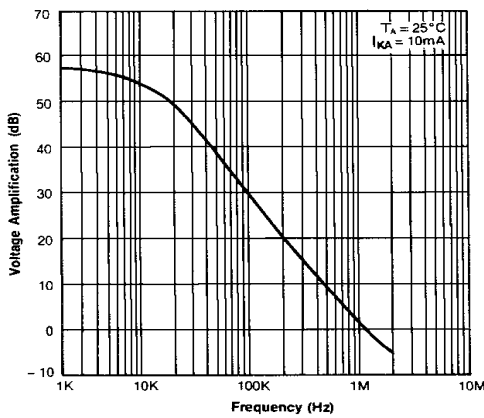

Figure 8. Small Signal Voltage Amplification vs. Frequency

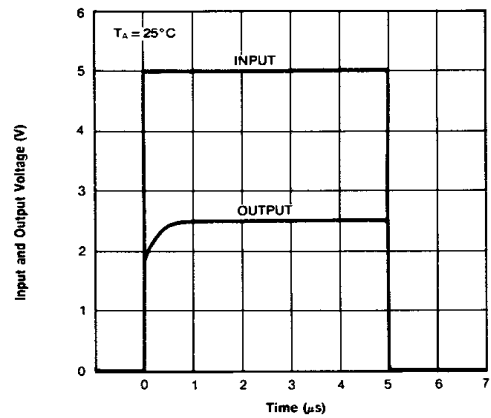

Figure 9. Pulse Response

Typical Performance Characteristics (Continued)

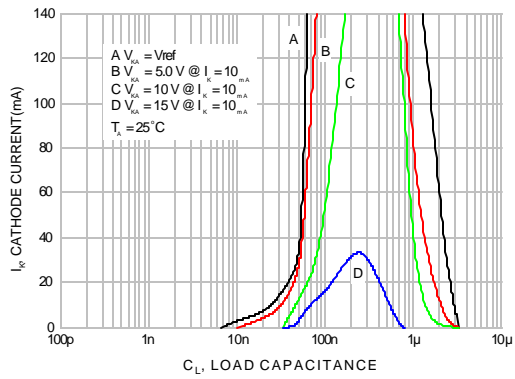

Figure 10. Stability Boundary Conditions

Typical Application

$$V_O = \left(1 + \frac{R_1}{R_2}\right)V_{ref}$$

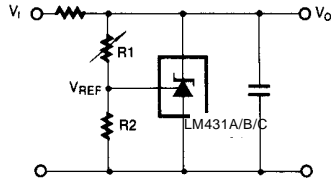

Figure 11. Shunt Regulator

$$V_O = V_{ref} \left(1 + \frac{R_1}{R_2}\right)$$

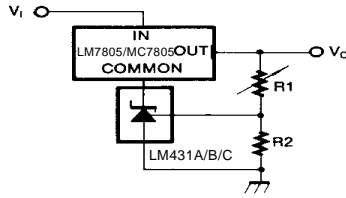

Figure 12. Output Control for Three-Terminal Fixed Regulator

$$V_O = \left(1 + \frac{R_1}{R_2}\right)V_{ref}$$

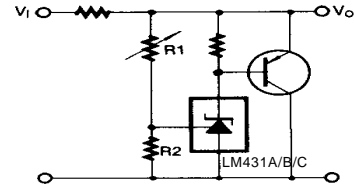

Figure 13. High Current Shunt Regulator

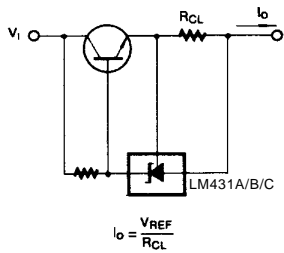

Figure 14. Current Limit or Current Source

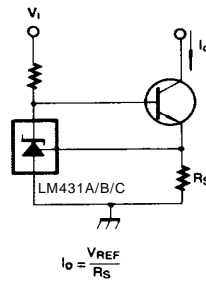

Figure 15. Constant-Current Sink

Mechanical Dimensions

Package

Dimensions in millimeters

TO-92

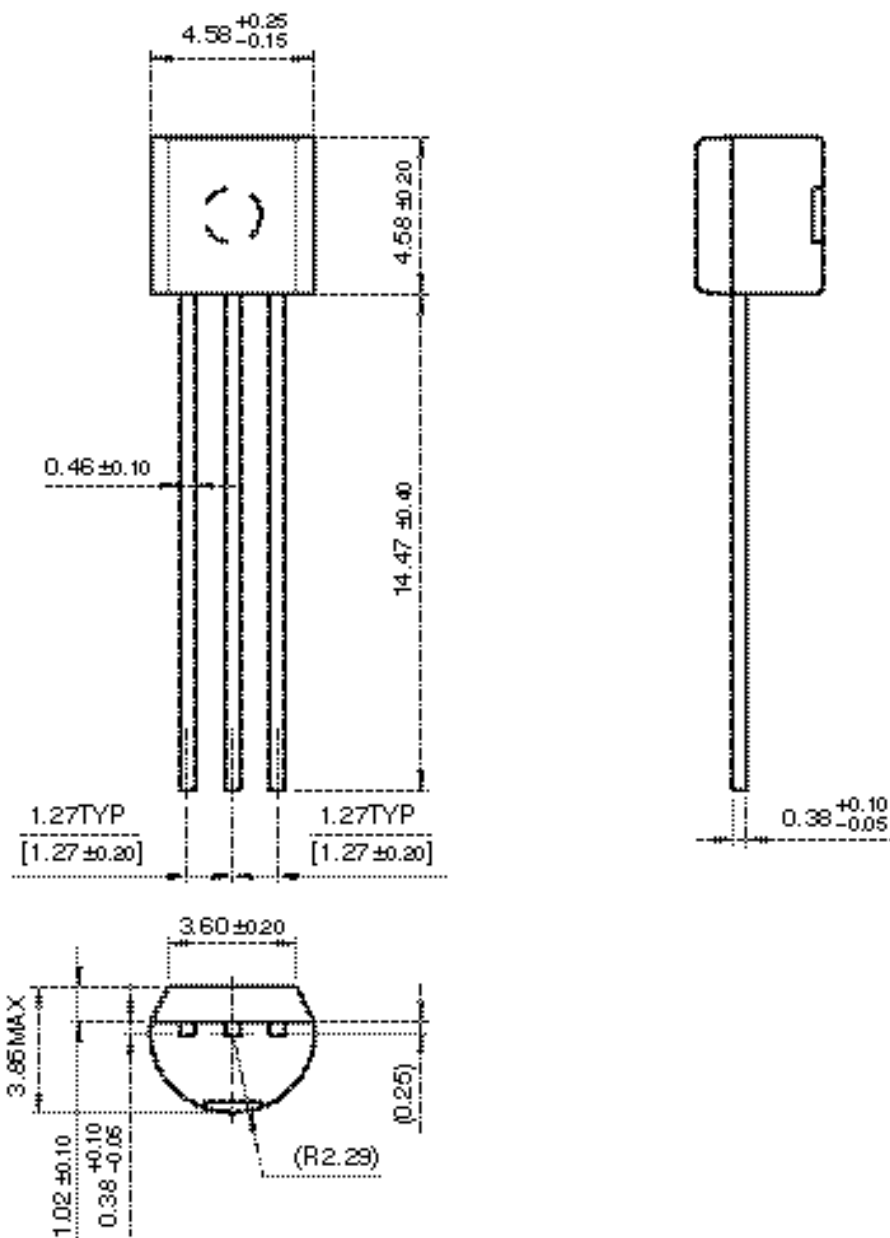

Mechanical Dimensions (Continued)

Package

Dimensions in millimeters

8-SOP

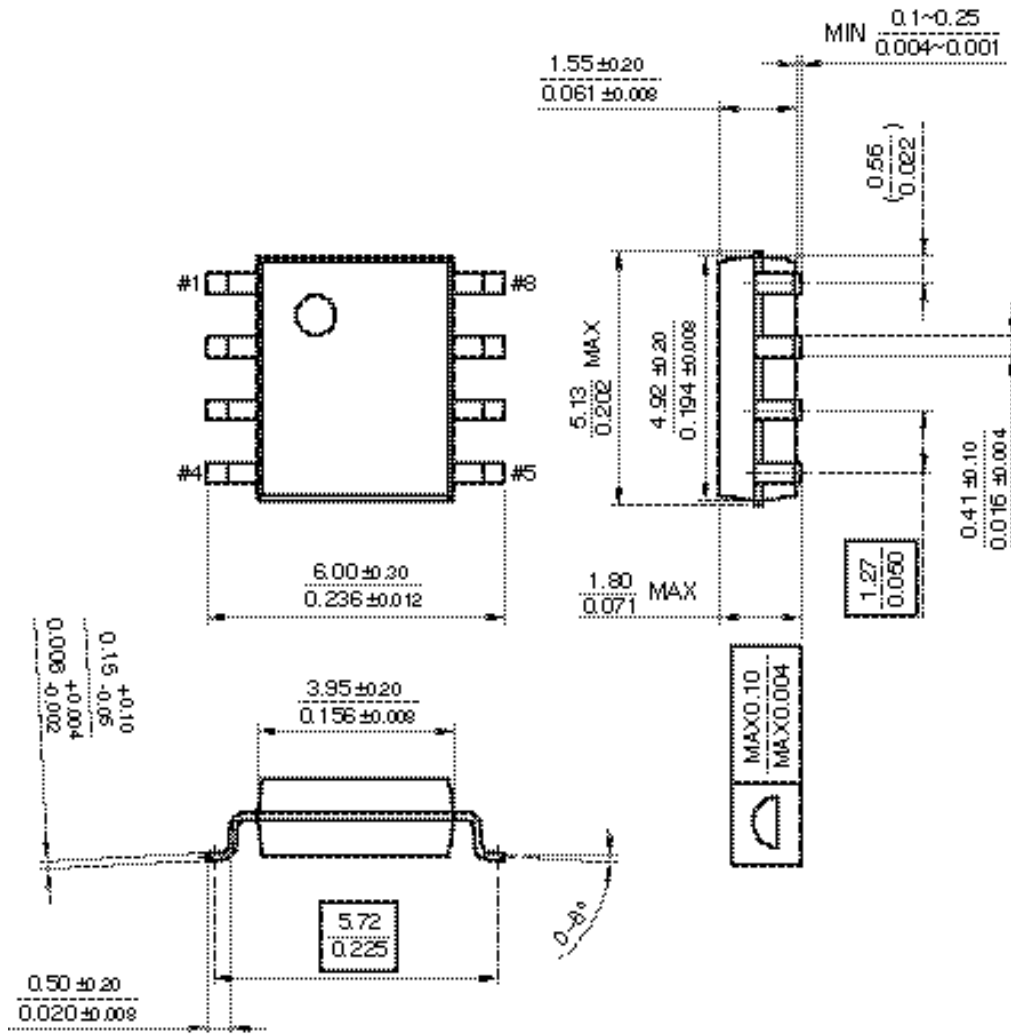

Mechanical Dimensions (Continued)

Package

Dimensions in millimeters

8-DIP

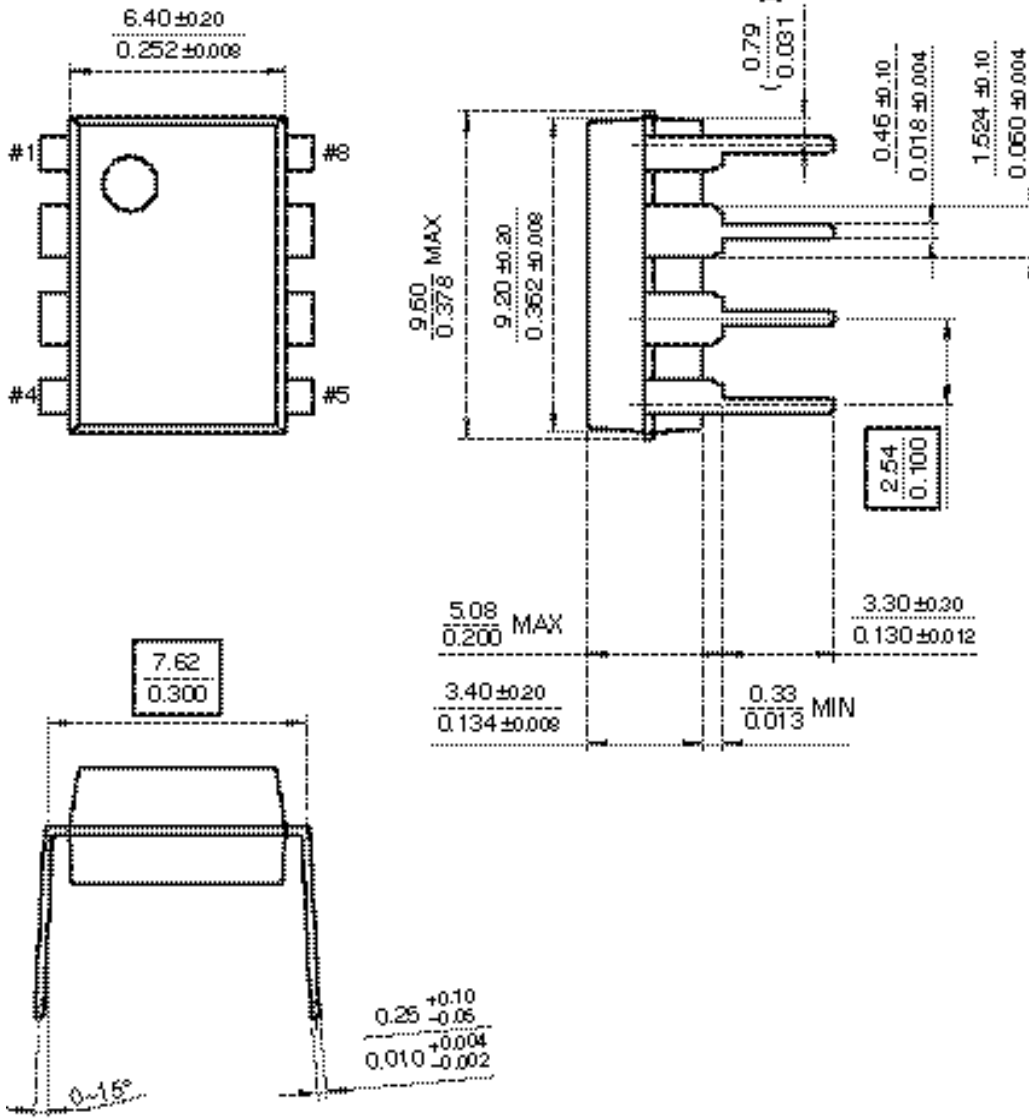

Ordering Information

Product Number	Output Voltage Tolerance	Package	Operating Temperature	
LM431CCZ	0.5%	TO-92	-25 ~ +85 °C	
LM431CCM		8-SOP		
LM431BCZ	1%	TO-92		
LM431BCM		8-SOP		
LM431ACN	2%	8-DIP		
LM431ACZ		TO-92		
LM431ACM		8-SOP		
LM431CIZ	0.5%	TO-92		-40 ~ +85 °C
LM431CIM		8-SOP		
LM431BIZ	1%	TO-92		
LM431BIM		8-SOP		
LM431AIZ	2%	TO-92		
LM431AIM		8-SOP		

DISCLAIMER

FAIRCHILD SEMICONDUCTOR RESERVES THE RIGHT TO MAKE CHANGES WITHOUT FURTHER NOTICE TO ANY PRODUCTS HEREIN TO IMPROVE RELIABILITY, FUNCTION OR DESIGN. FAIRCHILD DOES NOT ASSUME ANY LIABILITY ARISING OUT OF THE APPLICATION OR USE OF ANY PRODUCT OR CIRCUIT DESCRIBED HEREIN; NEITHER DOES IT CONVEY ANY LICENSE UNDER ITS PATENT RIGHTS, NOR THE RIGHTS OF OTHERS.

LIFE SUPPORT POLICY

FAIRCHILD' S PRODUCTS ARE NOT AUTHORIZED FOR USE AS CRITICAL COMPONENTS IN LIFE SUPPORT DEVICES OR SYSTEMS WITHOUT THE EXPRESS WRITTEN APPROVAL OF THE PRESIDENT OF FAIRCHILD SEMICONDUCTOR CORPORATION. As used herein:

1. Life support devices or systems are devices or systems which, (a) are intended for surgical implant into the body, or (b) support or sustain life, and (c) whose failure to perform when properly used in accordance with instructions for use provided in the labeling, can be reasonably expected to result in a significant injury of the user.
2. A critical component in any component of a life support device or system whose failure to perform can be reasonably expected to cause the failure of the life support device or system, or to affect its safety or effectiveness.

Fairchild Semiconductor

SEARCH | [Parametric](#) | [Cross Reference](#)[space](#)[Product Folders and](#)[Appliea](#)[find products](#)[Home](#) >> [Find products](#) >>[Products groups](#)[Analog and Mixed](#)[Signal](#)[Discrete](#)[Interface](#)[Logic](#)[Microcontrollers](#)[Non-Volatile](#)[Memory](#)[Optoelectronics](#)[Markets and](#)[applications](#)[New products](#)[Product selection and](#)[parametric search](#)[Cross-reference](#)[search](#)[technical information](#)[buy products](#)[technical support](#)[my Fairchild](#)[company](#)

LM431A

Adjustable/2.5V, 2% Tolerance Shunt
Regulator

Contents

[General description](#) | [Features](#) | [Product
status/pricing/packaging](#) | [Application notes](#)

General description

The LM431A/LM431B/LM431C are three-terminal output adjustable regulators with thermal stability over operating temperature range. The output voltage can be set any value between V_{REF} (approximately 2.5 volts) and 36 volts with two external resistors. These devices have a typical dynamic output impedance of 0.2Ω . Active output circuit provides a sharp turn-on characteristic, making these devices excellent replacement for Zener Diodes in many applications.

[back to top](#)

Features

- Programmable output voltage to 36 volts
- Low dynamic output impedance 0.20 typical
- Sink current capability of 1.0 to 100mA
- Equivalent full-range temperature coefficient of 50ppm/°C typical
- Temperature compensated for operation over full rated operating temperature range
- Low output noise voltage
- Fast turn-on response

[back to top](#)[Related Links](#)[Request samples](#)[Dotted line](#)[How to order products](#)[Dotted line](#)[Product Change Notices](#)[\(PCNs\)](#)[Dotted line](#)[Support](#)[Dotted line](#)[Distributor and field sales](#)[representatives](#)[Dotted line](#)[Quality and reliability](#)[Dotted line](#)[Design tools](#)

Datasheet

[Download this](#)[datasheet](#)[PDF](#)[e-mail this datasheet](#)[\[E-](#)This page [Print version](#)

Product status/pricing/packaging

Product	Product status	Package type	Leads	Package marking	Packing method
LM431ACZ	Full Production	TO-92	3	\$N&2&T LM431 ACZ	BULK
LM431AIMX	Full Production	SOIC	8	N/A	TAPE REEL
LM431AIZX	Full Production	TO-92	3	N/A	TAPE REEL
LM431AIM	Full Production	SOIC	8	N/A	RAIL
LM431ACMX	Full Production	SOIC	8	N/A	TAPE REEL
LM431ACM	Full Production	SOIC	8	N/A	RAIL
LM431ACZX	Full Production	TO-92	3	N/A	TAPE REEL
LM431AIZXA	Full Production	TO-92	3	N/A	TAPE REEL
LM431ACZXA	Full Production	TO-92	3	N/A	TAPE REEL
LM431AIZ	Full Production	TO-92	3	N/A	BULK

[back to top](#)

Application notes

[AN-42043: AN-42043 ML4803 240W Off-Line Power Supply with PFC](#)
(296 K) Jul 19, 2002

[back to top](#)

[Home](#) | [Find products](#) | [Technical information](#) | [Buy products](#) |
[Support](#) | [Company](#) | [Contact us](#) | [Site index](#) | [Privacy policy](#)

© Copyright 2002 Fairchild Semiconductor

Fairchild Semiconductor

SEARCH | [Parametric](#) | [Cross Reference](#)[space](#)[Product Folders and](#)[Appliea](#)[find products](#)[Home](#) >> [Find products](#) >>[Products groups](#)[Analog and Mixed](#)[Signal](#)[Discrete](#)[Interface](#)[Logic](#)[Microcontrollers](#)[Non-Volatile](#)[Memory](#)[Optoelectronics](#)[Markets and](#)[applications](#)[New products](#)[Product selection and](#)[parametric search](#)[Cross-reference](#)[search](#)[technical information](#)[buy products](#)[technical support](#)[my Fairchild](#)[company](#)

LM431B

Adjustable/2.5V, 1% Tolerance Shunt Regulator

Contents

[General description](#) | [Features](#) | [Product status/pricing/packaging](#)

General description

The LM431A/LM431B/LM431C are three-terminal output adjustable regulators with thermal stability over operating temperature range. The output voltage can be set any value between V_{REF} (approximately 2.5 volts) and 36 volts with two external resistors. These devices have a typical dynamic output impedance of 0.2Ω . Active output circuit provides a sharp turn-on characteristic, making these devices excellent replacement for Zener Diodes in many applications.

[back to top](#)

Features

- Programmable output voltage to 36 volts
- Low dynamic output impedance 0.20 typical
- Sink current capability of 1.0 to 100mA
- Equivalent full-range temperature coefficient of 50ppm/°C typical
- Temperature compensated for operation over full rated operating temperature range
- Low output noise voltage
- Fast turn-on response

[back to top](#)

Datasheet

[Download this datasheet](#)[PDF](#)[e-mail this datasheet](#)[\[E-](#)This page [Print version](#)

Related Links

[Request samples](#)[Dotted line](#)[How to order products](#)[Dotted line](#)[Product Change Notices](#)[\(PCNs\)](#)[Dotted line](#)[Support](#)[Dotted line](#)[Distributor and field sales](#)[representatives](#)[Dotted line](#)[Quality and reliability](#)[Dotted line](#)[Design tools](#)

Product status/pricing/packaging

Product	Product status	Package type	Leads	Package marking	Packing method
LM431BCMX	Full Production	SOIC	8	N/A	TAPE REEL
LM431BIZX	Full Production	TO-92	3	N/A	TAPE REEL
LM431BIZXA	Full Production	TO-92	3	N/A	TAPE REEL
LM431BCZ	Full Production	TO-92	3	\$N&2&T LM431 BCZ	BULK
LM431BCZXA	Full Production	TO-92	3	N/A	TAPE REEL
LM431BIMX	Full Production	SOIC	8	N/A	TAPE REEL
LM431BIZ	Full Production	TO-92	3	N/A	BULK
LM431BCM	Full Production	SOIC	8	N/A	RAIL
LM431BCZX	Full Production	TO-92	3	N/A	TAPE REEL
LM431BIM	Full Production	SOIC	8	N/A	RAIL

[back to top](#)

[Home](#) | [Find products](#) | [Technical information](#) | [Buy products](#) |
[Support](#) | [Company](#) | [Contact us](#) | [Site index](#) | [Privacy policy](#)

© Copyright 2002 Fairchild Semiconductor

Fairchild Semiconductor

SEARCH | [Parametric](#) | [Cross Reference](#)[space](#)[Product Folders and](#)[Appliea](#)[find products](#)[Home](#) >> [Find products](#) >>[Products groups](#)[Analog and Mixed](#)[Signal](#)[Discrete](#)[Interface](#)[Logic](#)[Microcontrollers](#)[Non-Volatile](#)[Memory](#)[Optoelectronics](#)[Markets and](#)[applications](#)[New products](#)[Product selection and](#)[parametric search](#)[Cross-reference](#)[search](#)[technical information](#)[buy products](#)[technical support](#)[my Fairchild](#)[company](#)

LM431C

Adjustable/2.5V, 0.5% Tolerance Shunt Regulator

Contents

[General description](#) | [Features](#) | [Product status/pricing/packaging](#)

General description

The LM431A/LM431B/LM431C are three-terminal output adjustable regulators with thermal stability over operating temperature range. The output voltage can be set any value between V_{REF} (approximately 2.5 volts) and 36 volts with two external resistors. These devices have a typical dynamic output impedance of 0.2Ω . Active output circuit provides a sharp turn-on characteristic, making these devices excellent replacement for Zener Diodes in many applications.

[back to top](#)

Features

- Programmable output voltage to 36 volts
- Low dynamic output impedance 0.20 typical
- Sink current capability of 1.0 to 100mA
- Equivalent full-range temperature coefficient of 50ppm/°C typical
- Temperature compensated for operation over full rated operating temperature range
- Low output noise voltage
- Fast turn-on response

[back to top](#)

Related Links

[Request samples](#)[Dotted line](#)[How to order products](#)[Dotted line](#)[Product Change Notices](#)[\(PCNs\)](#)[Dotted line](#)[Support](#)[Dotted line](#)[Distributor and field sales](#)[representatives](#)[Dotted line](#)[Quality and reliability](#)[Dotted line](#)[Design tools](#)

Datasheet

[Download this](#)[datasheet](#)[PDF](#)[e-mail this datasheet](#)[\[E-](#)This page [Print version](#)

Product status/pricing/packaging

Product	Product status	Package type	Leads	Package marking	Packing method
LM431CCM	Full Production	SOIC	8	N/A	RAIL
LM431CCZXA	Full Production	TO-92	3	N/A	TAPE REEL
LM431CIMX	Full Production	SOIC	8	N/A	TAPE REEL
LM431CCZX	Full Production	TO-92	3	N/A	TAPE REEL
LM431CCMX	Full Production	SOIC	8	N/A	TAPE REEL
LM431CCZ	Full Production	TO-92	3	\$N&2&T LM431 CCZ	BULK
LM431CIM	Full Production	SOIC	8	N/A	RAIL
LM431CIZ	Full Production	TO-92	3	N/A	BULK
LM431CIZXA	Full Production	TO-92	3	N/A	TAPE REEL
LM431CIZX	Full Production	TO-92	3	N/A	TAPE REEL

[back to top](#)

[Home](#) | [Find products](#) | [Technical information](#) | [Buy products](#) |
[Support](#) | [Company](#) | [Contact us](#) | [Site index](#) | [Privacy policy](#)

© Copyright 2002 Fairchild Semiconductor