

4 x 45W quad bridge car radio amplifier

Features

- High output power:
 - 4 x 45 W / 4 Ω max.
 - 4 x 28 W / 4 Ω @ 14.4 V, 1 kHz, 10 %
- Low distortion
- Low output noise
- Standby function
- Mute function
- Automute at min. supply voltage detection
- Low external component count:
 - Internally fixed gain (26dB)
 - No external compensation
 - No bootstrap capacitors
- Clipping detector
- Offset detector
- Diagnostic facility for:
 - Out to GND short
 - Out to V_S short
 - Thermal shutdown

Protections:

- Output short circuit to GND, to V_S , across the load
- Very inductive loads
- Overrating chip temperature with soft thermal limiter

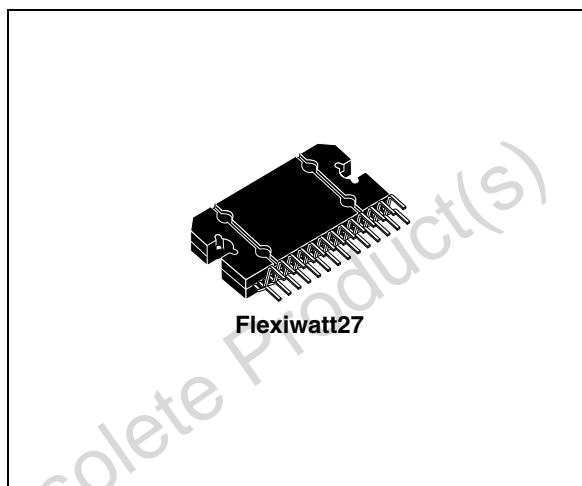

- Load dump voltage
- Fortuitous open GND
- Output DC offset detector
- Reversed battery
- ESD

Description

The TDA7389A is an AB class audio power amplifier, packaged in Flexiwatt 27 designed for high end car radio applications.

Based on the fully complementary PNP/NPN configuration the TDA7389A allows a rail to rail output voltage swing with no need of bootstrap capacitors.

Table 1. Device summary

Order code	Package	Packing
TDA7389A	Flexiwatt27	Tube

Contents

1	Pin connection and block diagrams	5
2	Electrical specifications	6
2.1	Absolute maximum ratings	6
2.2	Thermal data	6
2.3	Electrical characteristics	6
2.4	Electrical characteristic curves	8
2.5	Test and application circuit	10
3	Application hints	11
3.1	SVR	11
3.2	Input stage	11
3.3	Standby and muting	11
4	Package information	12
5	Revision history	13

Obsolete Product(s) - Obsolete Product(s)

List of tables

Table 1.	Device summary	1
Table 2.	Absolute maximum ratings	6
Table 3.	Thermal data	6
Table 4.	Electrical characteristics	6
Table 5.	Document revision history	13

Obsolete Product(s) - Obsolete Product(s)

List of figures

Figure 1.	Block diagram	5
Figure 2.	Pin connection (top view)	5
Figure 3.	Quiescent current vs. supply voltage	8
Figure 4.	Quiescent output voltage vs. supply voltage	8
Figure 5.	Output power vs. supply voltage	8
Figure 6.	Maximum output power vs. supply voltage	8
Figure 7.	Distortion vs. output power	8
Figure 8.	Distortion vs. frequency	8
Figure 9.	Supply voltage rejection vs. frequency	9
Figure 10.	Crosstalk vs. frequency	9
Figure 11.	Output noise vs. source resistance	9
Figure 12.	Power dissipation and efficiency vs. output power	9
Figure 13.	ITU R-ARM frequency response, weighting filter for transient pop.	9
Figure 14.	Test and application circuit	10
Figure 15.	Flexiwatt27 mechanical data and package dimensions	12

1 Pin connection and block diagrams

Figure 1. Block diagram

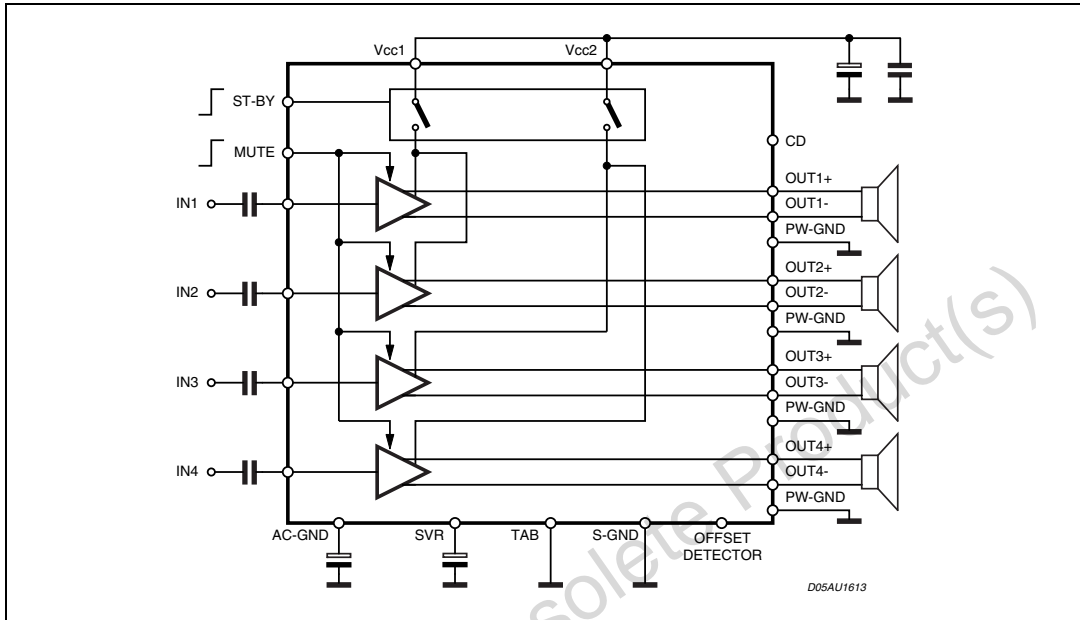
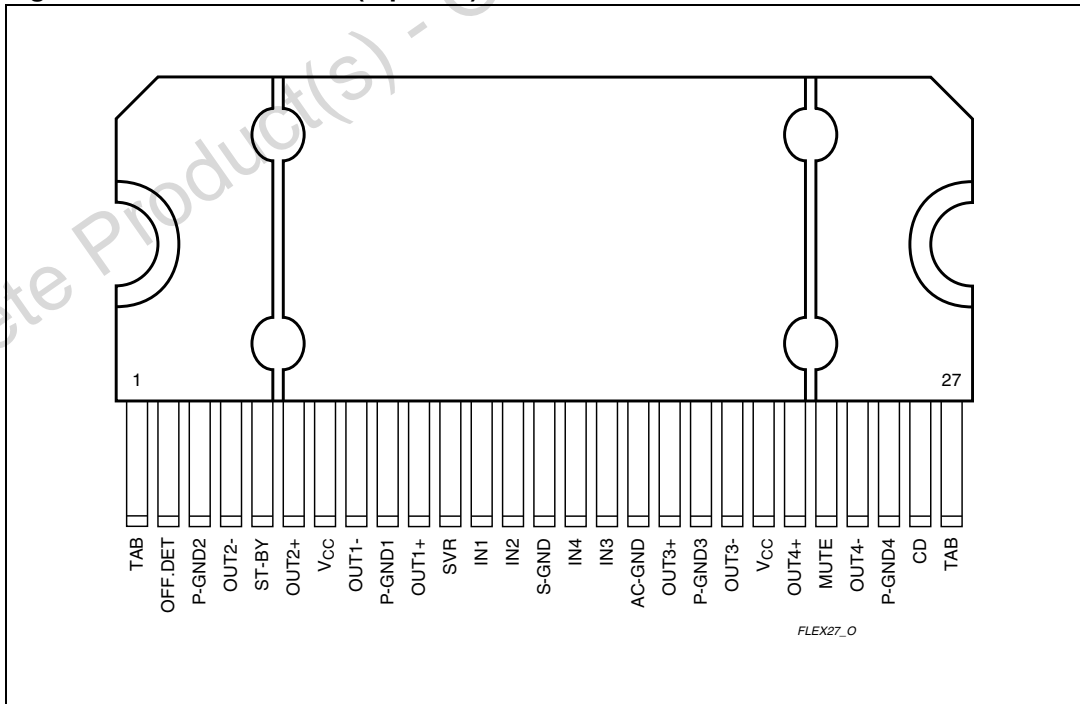

Figure 2. Pin connection (top view)



2 Electrical specifications

2.1 Absolute maximum ratings

Table 2. Absolute maximum ratings

Symbol	Parameter	Value	Unit
V_S	Operating supply voltage	18	V
$V_{S(DC)}$	DC supply voltage	28	V
$V_{S(pk)}$	Peak supply voltage (t = 50ms)	50	V
I_O	Output peak current: Repetitive (duty cycle 10% at f = 10Hz)	4.5	A
	Non repetitive (t = 100 μ s)	5.5	
P_{tot}	Power dissipation, (T _{case} = 70°C)	80	W
T_j	Junction temperature	150	°C
T_{stg}	Storage temperature	- 55 to 150	°C

2.2 Thermal data

Table 3. Thermal data

Symbol	Parameter	Value	Unit
$R_{th\ j-case}$	Thermal resistance junction to case max.	1	°C/W

2.3 Electrical characteristics

Table 4. Electrical characteristics

($V_S = 14.4V$; f = 1KHz; $R_g = 600\Omega$; $R_L = 4\Omega$; $T_{amb} = 25^\circ C$; Refer to the test and application diagram ([Figure 14](#)), unless otherwise specified.)

Symbol	Parameter	Test condition	Min.	Typ.	Max.	Unit
I_{q1}	Quiescent current	$R_L = \infty$		150	350	mA
V_{OS}	Output offset voltage	Play Mode			± 80	mV
dV_{OS}	During mute on/off output offset voltage	ITU R-ARM weighted see Figure 13	-10		10	mV
	During standby on/off output offset voltage		-50		50	
G_v	Voltage gain		25	26	27	dB
ΔG_v	Channel gain unbalance				± 1	dB
P_o	Output power	THD = 10%; $V_S = 14.4V$	26	28		W
$P_{o\ max}$	Max.output power ⁽¹⁾	$V_S = 14.4V$	41	45		W

Table 4. Electrical characteristics (continued)

($V_S = 14.4V$; $f = 1KHz$; $R_G = 600\Omega$; $R_L = 4\Omega$; $T_{amb} = 25^\circ C$; Refer to the test and application diagram (Figure 14), unless otherwise specified.)

Symbol	Parameter	Test condition	Min.	Typ.	Max.	Unit
THD	Distortion	$P_o = 4W$		0.04	0.10	%
e_{No}	Output noise	"A" Weighted		50	70	μV
		Bw = 20 Hz to 20 kHz		70	100	μV
SVR	Supply voltage rejection	$f = 100Hz$; $V_r = 1V_{rms}$	50	75		dB
f_{ch}	High cut-off frequency	$P_o = 0.5W$	100	200		KHz
R_i	Input Impedance		70	100	150	$K\Omega$
C_T	Cross talk	$f = 1 kHz$; $P_o = 4W$	60	75		dB
		$f = 10 kHz$; $P_o = 4W$		60		dB
I_{SB}	Standby current consumption	$V_{St-by} = 1.2V$			50	μA
		$V_{St-by} = 0V$			25	μA
I_{pin4}	Standby pin current	$V_{St-by} = 1.2$ to $2.6V$			± 1	μA
$V_{SB out}$	Standby Out threshold voltage	(Amp: On)	2.6			V
$V_{SB IN}$	Standby In threshold voltage	(Amp: Off)			1.2	V
A_M	Mute attenuation	$P_{Oref} = 4 W$	80	90		dB
$V_{M out}$	Mute Out threshold voltage	(Amp: play)	2.6			V
$V_{M in}$	Mute In threshold voltage	(Amp: mute)			1.2	V
$V_{AM in}$	V_S automute threshold	(Amp: mute); Att ≥ 80 dB; $P_{Oref} = 4 \Omega$ (Amp: play); Att < 0.1 dB; $P_o = 0.5 W$		7.6	8.5	V
I_{pin22}	Muting pin current	$V_{MUTE} = 1.2 V$ (Source current)	5	11	20	μA
		$V_{MUTE} = 2.6 V$	-5	-	-20	μA
Offset detector						
OD_{LK}	OD leakage current				1	μA
V_{off}	Detected diff. output offset	$V_{St-by} = 5 V$	1.5	± 2	2.5	V
V_{Pin2_Fw27}	Pin2_Fw27 voltage for Detection = True	$I_{pin2} = 1 mA$ $V_{St-by} = 5V$; $ V_{off} > 2.5 V$		0.2	0.4	V
Clipping detector						
CD_{LK}	Clip det high leakage current	CD Off			1	μA
CD_{SAT}	Clip det sat voltage	DC On; $I_{CD} = 1 mA$		0.2	0.4	V
CD_{THD}	Clip det THD level	$P_o > 16 W$			2	%

1. Saturated square wave output.

2.4 Electrical characteristic curves

Figure 3. Quiescent current vs. supply voltage

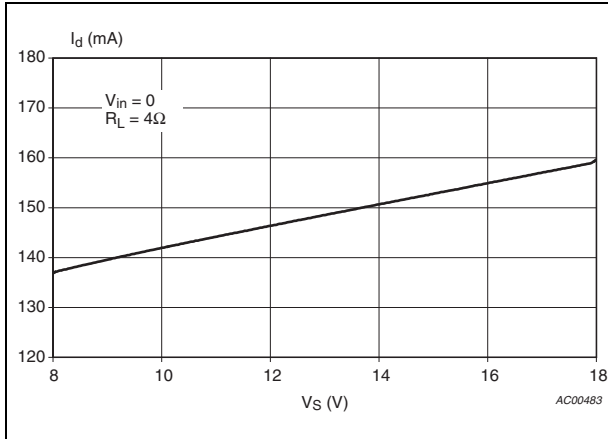

Figure 4. Quiescent output voltage vs. supply voltage

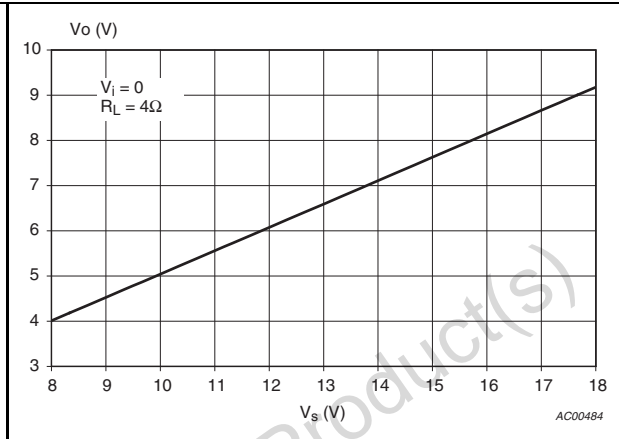

Figure 5. Output power vs. supply voltage

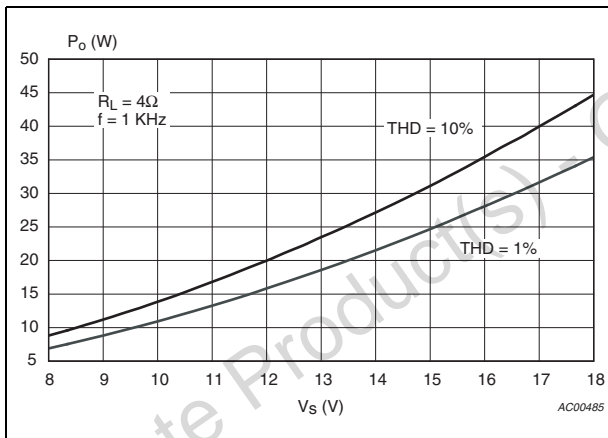

Figure 6. Maximum output power vs. supply voltage

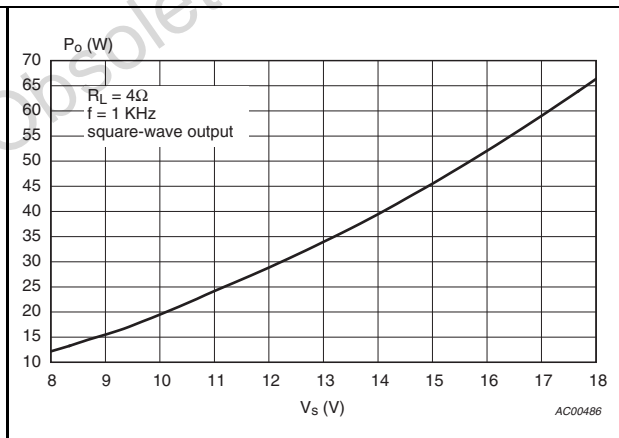

Figure 7. Distortion vs. output power

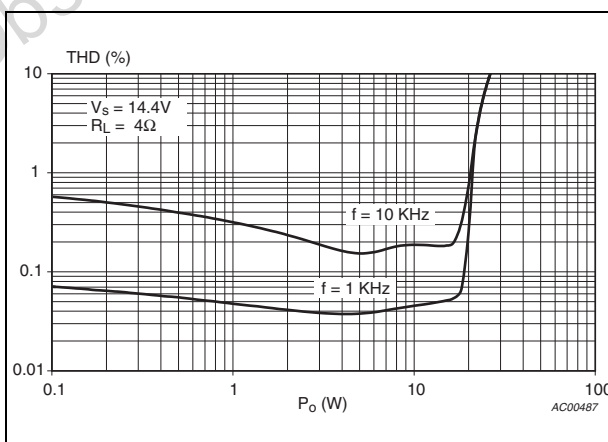

Figure 8. Distortion vs. frequency

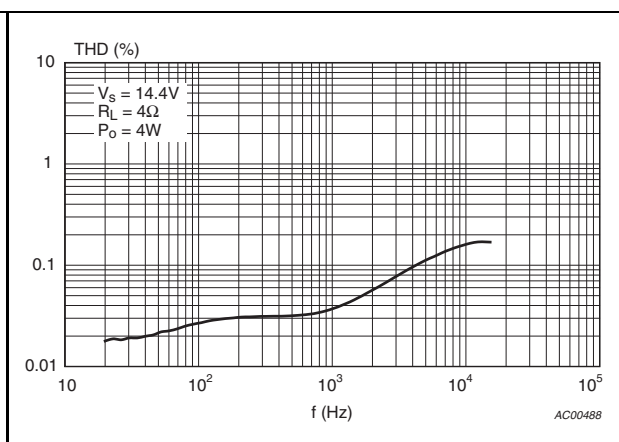

Figure 9. Supply voltage rejection vs. frequency

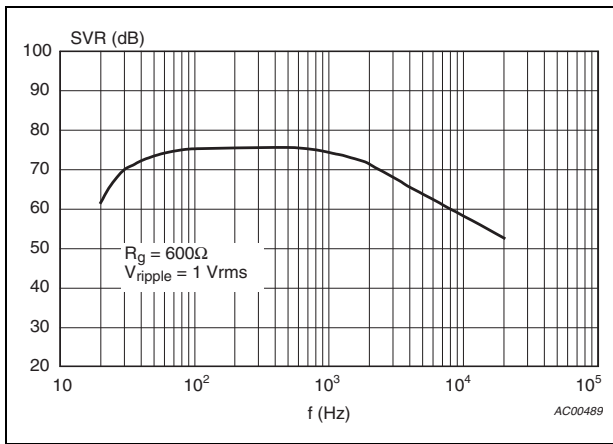

Figure 10. Crosstalk vs. frequency

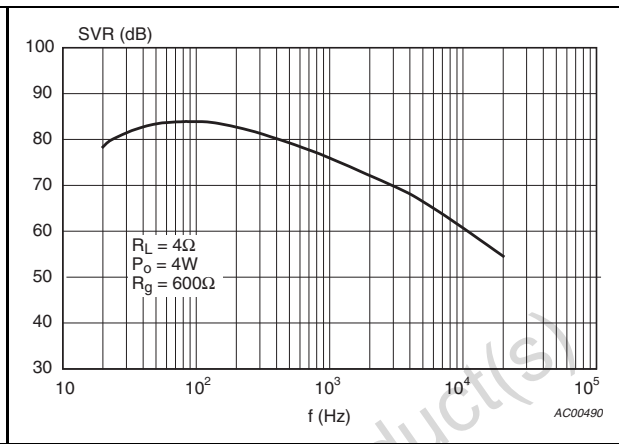

Figure 11. Output noise vs. source resistance

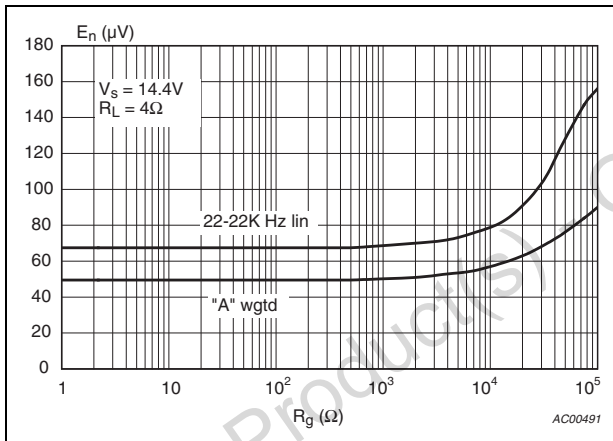

Figure 12. Power dissipation and efficiency vs. output power

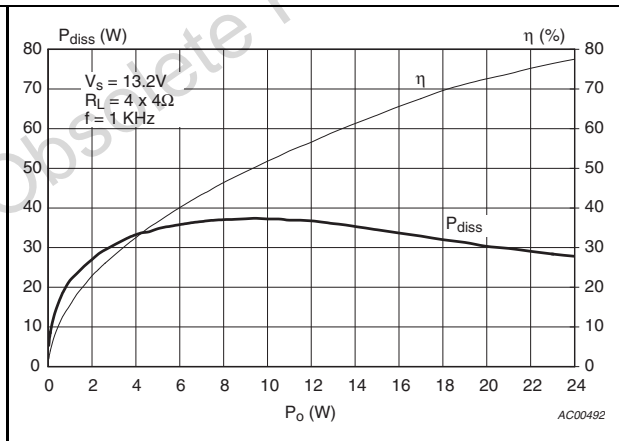
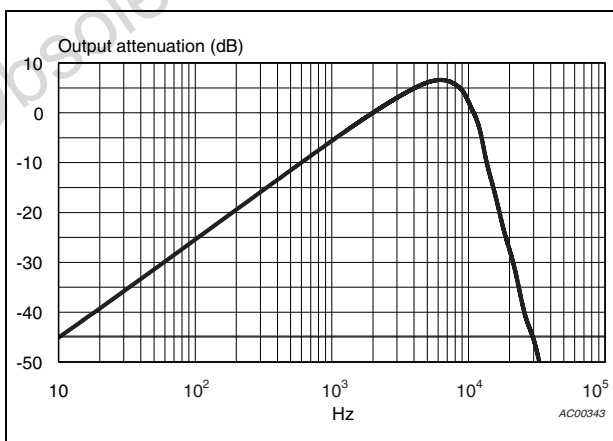
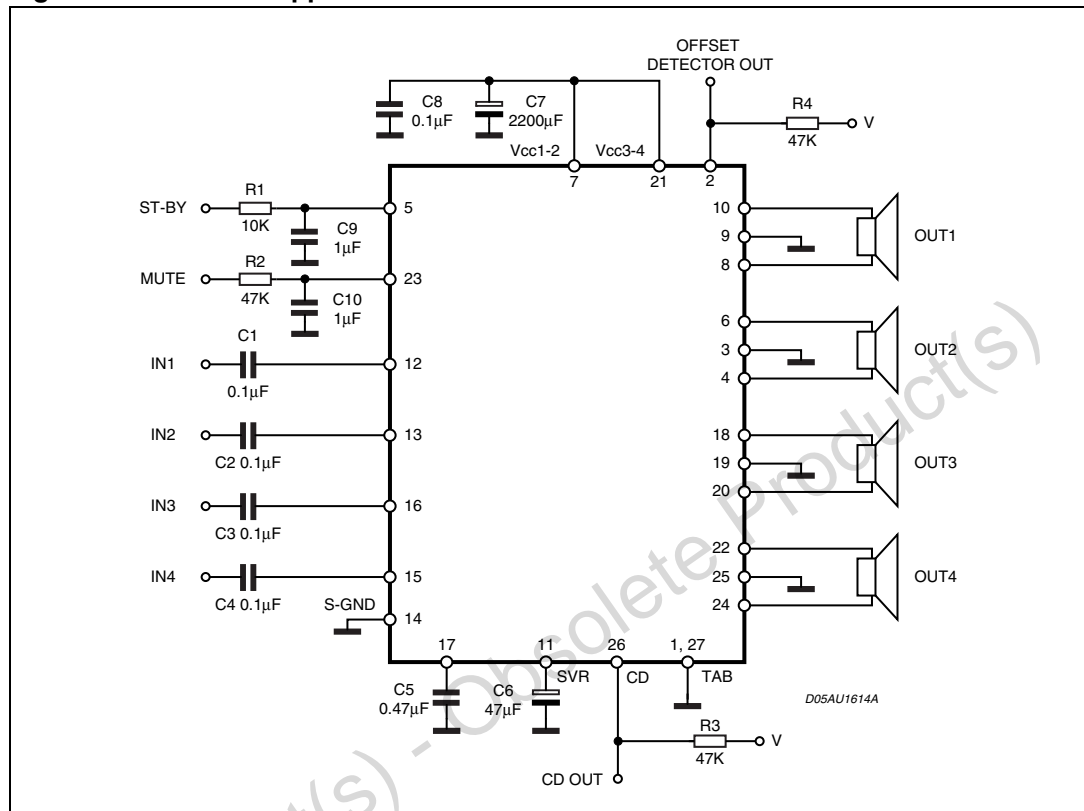

Figure 13. ITU R-ARM frequency response, weighting filter for transient pop



2.5 Test and application circuit

Figure 14. Test and application circuit



3 Application hints

Ref. to the circuit of [Figure 14](#).

3.1 SVR

Besides its contribution to the ripple rejection, the SVR capacitor governs the turn ON/OFF time sequence and, consequently, plays an essential role in the pop optimization during ON/OFF transients.

To conveniently serve both needs, **its minimum recommended value is 22 μ F**, 47 μ F can be used to optimize pop performances.

3.2 Input stage

The TDA7389A's inputs are ground-compatible and can stand very high input signals (± 8 Vpk) without any performances degradation.

If the standard value for the input capacitors (0.1 μ F) is adopted, the low frequency cut-off will amount to 16 Hz.

The input capacitors should be 1/4 of the capacitor connected to AC-GND pin for optimum pop performances.

3.3 Standby and muting

Standby and muting facilities are both 3.3 V CMOS-compatible. If unused, a straight connection to V_s of their respective pins would be admissible.

Conventional/low-power transistors can be employed to drive muting and stand-by pins in absence of true CMOS ports or microprocessors. R-C cells have always to be used in order to smooth down the transitions for preventing any audible transient noises.

Since a DC current of about 10 μ A normally flows out of pin 23, the maximum allowable muting-series resistance (R_2) is 70 k Ω , which is sufficiently high to permit a muting capacitor reasonably small (about 1 μ F).

If R_2 is higher than recommended, the involved risk will be that the voltage at pin 23 may rise to above the 1.2 V threshold voltage and the device will consequently fail to turn OFF when the mute line is brought down.

About the stand-by, the time constant to be assigned in order to obtain a virtually pop-free transition has to be slower than 2.5V/ms.

4 Package information

In order to meet environmental requirements, ST (also) offers these devices in ECOPACK® packages. ECOPACK® packages are lead-free. The category of second Level Interconnect is marked on the package and on the inner box label, in compliance with JEDEC Standard JESD97. The maximum ratings related to soldering conditions are also marked on the inner box label.

ECOPACK is an ST trademark. ECOPACK specifications are available at: www.st.com.

Figure 15. Flexiwatt27 mechanical data and package dimensions

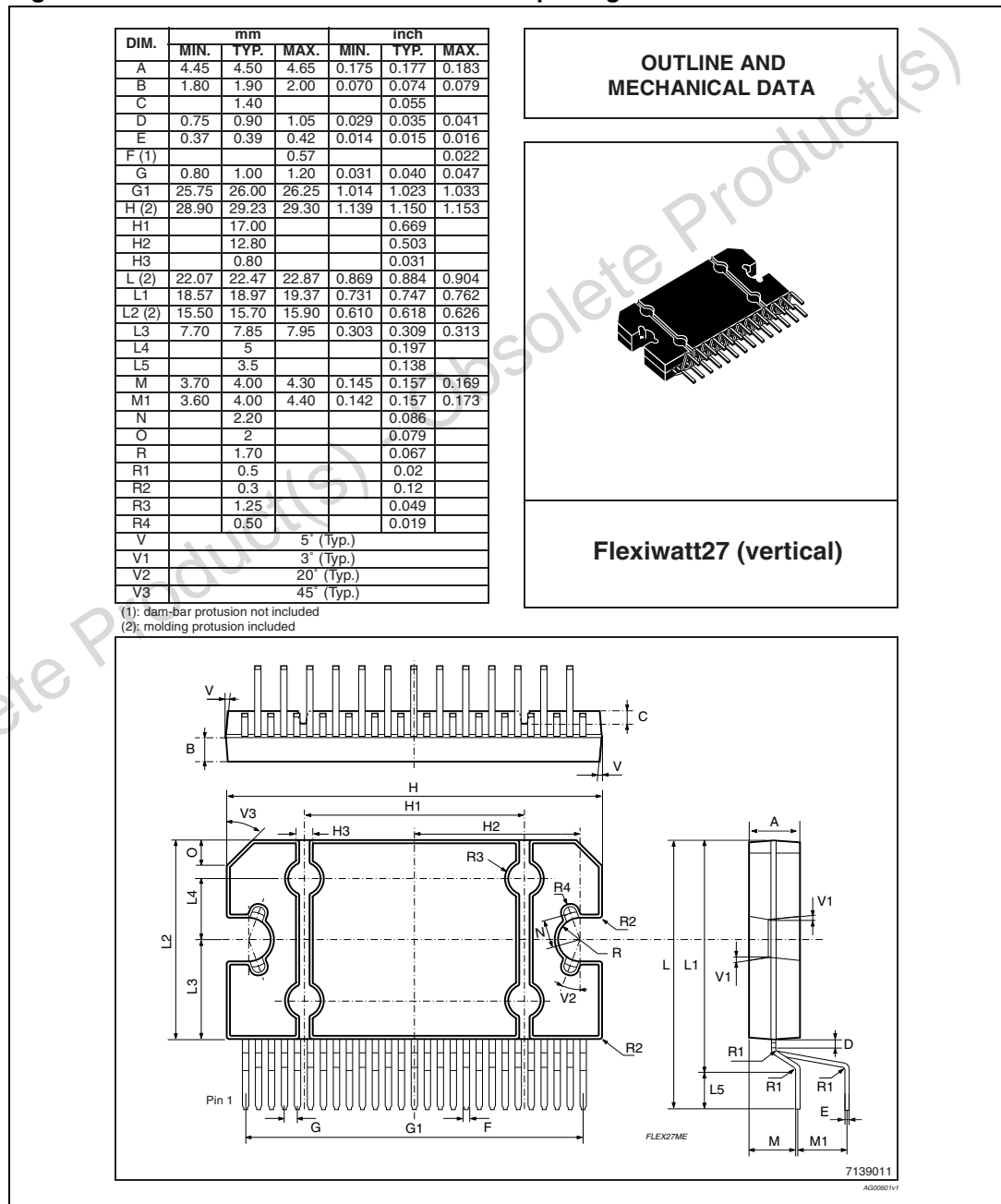

5 Revision history

Table 5. Document revision history

Date	Revision	Changes
14-Nov-2007	1	Initial release.
20-Oct-2008	2	Updated the Table 3: Thermal data on page 6 .
17-Sep-2013	3	Updated Disclaimer.

Obsolete Product(s) - Obsolete Product(s)

Please Read Carefully:

Information in this document is provided solely in connection with ST products. STMicroelectronics NV and its subsidiaries ("ST") reserve the right to make changes, corrections, modifications or improvements, to this document, and the products and services described herein at any time, without notice.

All ST products are sold pursuant to ST's terms and conditions of sale.

Purchasers are solely responsible for the choice, selection and use of the ST products and services described herein, and ST assumes no liability whatsoever relating to the choice, selection or use of the ST products and services described herein.

No license, express or implied, by estoppel or otherwise, to any intellectual property rights is granted under this document. If any part of this document refers to any third party products or services it shall not be deemed a license grant by ST for the use of such third party products or services, or any intellectual property contained therein or considered as a warranty covering the use in any manner whatsoever of such third party products or services or any intellectual property contained therein.

UNLESS OTHERWISE SET FORTH IN ST'S TERMS AND CONDITIONS OF SALE ST DISCLAIMS ANY EXPRESS OR IMPLIED WARRANTY WITH RESPECT TO THE USE AND/OR SALE OF ST PRODUCTS INCLUDING WITHOUT LIMITATION IMPLIED WARRANTIES OF MERCHANTABILITY, FITNESS FOR A PARTICULAR PURPOSE (AND THEIR EQUIVALENTS UNDER THE LAWS OF ANY JURISDICTION), OR INFRINGEMENT OF ANY PATENT, COPYRIGHT OR OTHER INTELLECTUAL PROPERTY RIGHT.

ST PRODUCTS ARE NOT DESIGNED OR AUTHORIZED FOR USE IN: (A) SAFETY CRITICAL APPLICATIONS SUCH AS LIFE SUPPORTING, ACTIVE IMPLANTED DEVICES OR SYSTEMS WITH PRODUCT FUNCTIONAL SAFETY REQUIREMENTS; (B) AERONAUTIC APPLICATIONS; (C) AUTOMOTIVE APPLICATIONS OR ENVIRONMENTS, AND/OR (D) AEROSPACE APPLICATIONS OR ENVIRONMENTS. WHERE ST PRODUCTS ARE NOT DESIGNED FOR SUCH USE, THE PURCHASER SHALL USE PRODUCTS AT PURCHASER'S SOLE RISK, EVEN IF ST HAS BEEN INFORMED IN WRITING OF SUCH USAGE, UNLESS A PRODUCT IS EXPRESSLY DESIGNATED BY ST AS BEING INTENDED FOR "AUTOMOTIVE, AUTOMOTIVE SAFETY OR MEDICAL" INDUSTRY DOMAINS ACCORDING TO ST PRODUCT DESIGN SPECIFICATIONS. PRODUCTS FORMALLY ESCC, QML OR JAN QUALIFIED ARE DEEMED SUITABLE FOR USE IN AEROSPACE BY THE CORRESPONDING GOVERNMENTAL AGENCY.

Resale of ST products with provisions different from the statements and/or technical features set forth in this document shall immediately void any warranty granted by ST for the ST product or service described herein and shall not create or extend in any manner whatsoever, any liability of ST.

ST and the ST logo are trademarks or registered trademarks of ST in various countries.

Information in this document supersedes and replaces all information previously supplied.

The ST logo is a registered trademark of STMicroelectronics. All other names are the property of their respective owners.

© 2013 STMicroelectronics - All rights reserved

STMicroelectronics group of companies

Australia - Belgium - Brazil - Canada - China - Czech Republic - Finland - France - Germany - Hong Kong - India - Israel - Italy - Japan - Malaysia - Malta - Morocco - Philippines - Singapore - Spain - Sweden - Switzerland - United Kingdom - United States of America

www.st.com

Mouser Electronics

Authorized Distributor

Click to View Pricing, Inventory, Delivery & Lifecycle Information:

[STMicroelectronics:](#)

[TDA7389A](#)