

# LM431

## Adjustable Precision Zener Shunt Regulator

### General Description

The LM431 is a 3-terminal adjustable shunt regulator with guaranteed temperature stability over the entire temperature range of operation. The output voltage may be set at any level greater than 2.5V ( $V_{REF}$ ) up to 36V merely by selecting two external resistors that act as a voltage divided network. Due to the sharp turn-on characteristics this device is an excellent replacement for many zener diode applications.

### Features

- Average temperature coefficient 50 ppm/°C
- Temperature compensated for operation over the full temperature range
- Programmable output voltage
- Fast turn-on response
- Low output noise

### Connection Diagrams

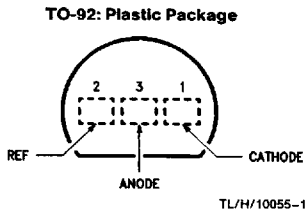

**Top View**  
 Order Number LM431ACZ,  
 LM431AIZ,  
 LM431BCZ, LM431BIZ, LM431CCZ  
 or LM431CIZ

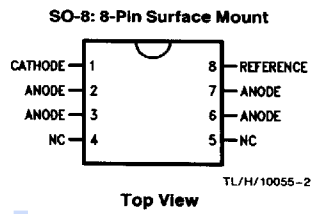

**Top View**  
 Order Number LM431ACM,  
 LM431AIM,  
 LM431BCM, LM431BIM, LM431CCM  
 or LM431CIM

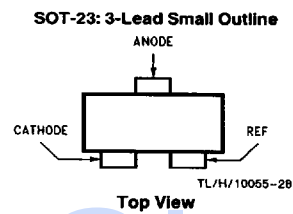

**Top View**  
 Order Number LM431ACM3,  
 LM431AIM3,  
 LM431BCM3, LM431BIM3,  
 LM431CCM3  
 or LM431CIM3

### Ordering Information\*

Package	Typical Accuracy			Temperature Range
	0.5%	1%	2%	
TO-92	LM431CCZ LM431CIZ	LM431BCZ LM431BIZ	LM431ACZ LM431AIZ	0°C to +70°C -40°C to +85°C
SO-8	LM431CCM LM431CIM	LM431BCM LM431BIM	LM431ACM LM431AIM	0°C to +70°C -40°C to +85°C
SOT-23	LM431CCM3 LM431CIM3	LM431BCM3 LM431BIM3	LM431ACM3 LM431AIM3	0°C to +70°C -40°C to +85°C

\*See Table 1 for package marking for SOT-23.

LM431 Adjustable Precision Zener Shunt Regulator

## Absolute Maximum Ratings

If Military/Aerospace specified devices are required, please contact the National Semiconductor Sales Office/Distributors for availability and specifications.

Storage Temperature Range	-65°C to +150°C
Operating Temperature Range	
Industrial (LM431xI)	-40°C to +85°C
Commercial (LM431xC)	0°C to +70°C
Lead Temperature	
TO-92 Package/SO-8 Package/SOT-23 Package (Soldering, 10 sec.)	265°C
Internal Power Dissipation (Notes 1, 2)	
TO-92 Package	0.78W
SO-8 Package	0.81W
SOT-23 Package	0.28W

Cathode Voltage		37V
Continuous Cathode Current	-10 mA to +150 mA	
Reference Voltage		-0.5V
Reference Input Current		10 mA
Operating Conditions	<b>Min</b>	<b>Max</b>
Cathode Voltage	V <sub>REF</sub>	37V
Cathode Current	1.0 mA	100 mA

Note 1: T<sub>J</sub> Max = 150°C.

Note 2: Ratings apply to ambient temperature at 25°C. Above this temperature, derate the TO-92 at 6.2 mW/°C, the SO-8 at 6.5 mW/°C, and the SOT-23 at 2.2 mW/°C.

## LM431

### Electrical Characteristics T<sub>A</sub> = 25°C unless otherwise specified

Symbol	Parameter	Conditions	Min	Typ	Max	Units
V <sub>REF</sub>	Reference Voltage	V <sub>Z</sub> = V <sub>REF</sub> , I <sub>I</sub> = 10 mA LM431A (Figure 1)	2.440	2.495	2.550	V
		V <sub>Z</sub> = V <sub>REF</sub> , I <sub>I</sub> = 10 mA LM431B (Figure 1)	2.470	2.495	2.520	V
		V <sub>Z</sub> = V <sub>REF</sub> , I <sub>I</sub> = 10 mA LM431C (Figure 1)	2.485	2.500	2.510	V
V <sub>DEV</sub>	Deviation of Reference Input Voltage Over Temperature (Note 3)	V <sub>Z</sub> = V <sub>REF</sub> , I <sub>I</sub> = 10 mA, T <sub>A</sub> = Full Range (Figure 1)		8.0	17	mV
$\frac{\Delta V_{REF}}{\Delta V_Z}$	Ratio of the Change in Reference Voltage to the Change in Cathode Voltage	I <sub>Z</sub> = 10 mA (Figure 2)				mV/V
		V <sub>Z</sub> from V <sub>REF</sub> to 10V		-1.4	-2.7	
		V <sub>Z</sub> from 10V to 36V		-1.0	-2.0	
I <sub>REF</sub>	Reference Input Current	R <sub>1</sub> = 10 kΩ, R <sub>2</sub> = ∞, I <sub>I</sub> = 10 mA (Figure 2)		2.0	4.0	μA
ΔI <sub>REF</sub>	Deviation of Reference Input Current over Temperature	R <sub>1</sub> = 10 kΩ, R <sub>2</sub> = ∞, I <sub>I</sub> = 10 mA, T <sub>A</sub> = Full Range (Figure 2)		0.4	1.2	μA
I <sub>Z(MIN)</sub>	Minimum Cathode Current for Regulation	V <sub>Z</sub> = V <sub>REF</sub> (Figure 1)		0.4	1.0	mA
I <sub>Z(OFF)</sub>	Off-State Current	V <sub>Z</sub> = 36V, V <sub>REF</sub> = 0V (Figure 3)		0.3	1.0	μA
r <sub>Z</sub>	Dynamic Output Impedance (Note 4)	V <sub>Z</sub> = V <sub>REF</sub> , LM431A, Frequency = 0 Hz (Figure 1)			0.75	Ω
		V <sub>Z</sub> = V <sub>REF</sub> , LM431B, LM431C Frequency = 0 Hz (Figure 1)			0.50	Ω

## LM431

### Electrical Characteristics $T_A = 25^\circ\text{C}$ unless otherwise specified (Continued)

**Note 3:** Deviation of reference input voltage,  $V_{DEV}$ , is defined as the maximum variation of the reference input voltage over the full temperature range.

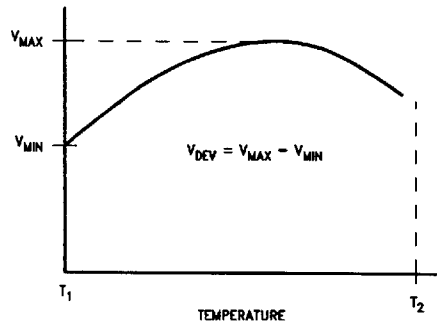

TL/H/10055-7

The average temperature coefficient of the reference input voltage,  $\alpha V_{REF}$ , is defined as:

$$\alpha V_{REF} \frac{\text{ppm}}{^\circ\text{C}} = \frac{\pm \left[ \frac{V_{\text{Max}} - V_{\text{Min}}}{V_{\text{REF}}(\text{at } 25^\circ\text{C})} \right] 10^6}{T_2 - T_1} = \frac{\pm \left[ \frac{V_{\text{DEV}}}{V_{\text{REF}}(\text{at } 25^\circ\text{C})} \right] 10^6}{T_2 - T_1}$$

Where:

$T_2 - T_1$  = full temperature change.

$\alpha V_{REF}$  can be positive or negative depending on whether the slope is positive or negative.

Example:  $V_{DEV} = 8.0 \text{ mV}$ ,  $V_{REF} = 2495 \text{ mV}$ ,  $T_2 - T_1 = 70^\circ\text{C}$ , slope is positive.

$$\alpha V_{REF} = \frac{\left[ \frac{8.0 \text{ mV}}{2495 \text{ mV}} \right] 10^6}{70^\circ\text{C}} = +46 \text{ ppm}/^\circ\text{C}$$

**Note 4:** The dynamic output impedance,  $r_z$ , is defined as:

$$r_z = \frac{\Delta V_Z}{\Delta I_Z}$$

When the device is programmed with two external resistors,  $R_1$  and  $R_2$ , (see Figure 2), the dynamic output impedance of the overall circuit,  $r_z$ , is defined as:

$$r_z = \frac{\Delta V_Z}{\Delta I_Z} = \left[ r_z \left( 1 + \frac{R_1}{R_2} \right) \right]$$

## Equivalent Circuit

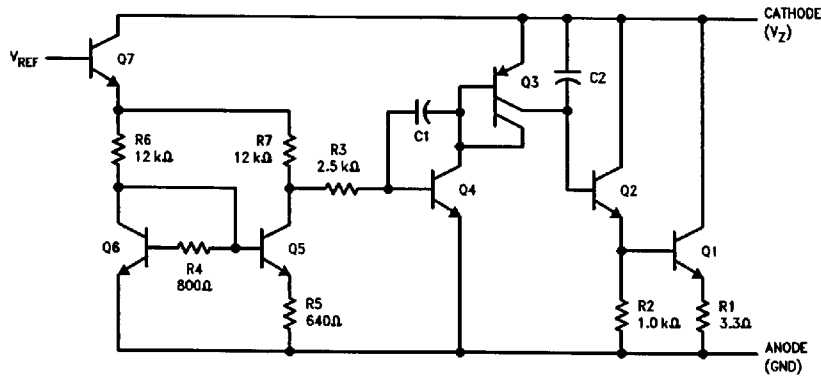

TL/H/10055-3

## DC Test Circuits

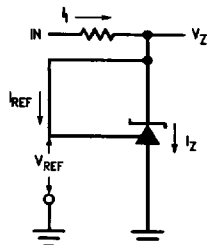

TL/H/10055-4

FIGURE 1. Test Circuit for  $V_Z = V_{REF}$

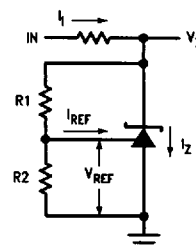

TL/H/10055-5

Note:  $V_Z = V_{REF} (1 + R1/R2) + I_{REF} \cdot R1$

FIGURE 2. Test Circuit for  $V_Z > V_{REF}$

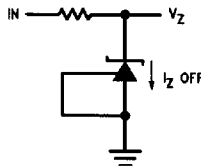

TL/H/10055-6

FIGURE 3. Test Circuit for Off-State Current

# Typical Performance Characteristics

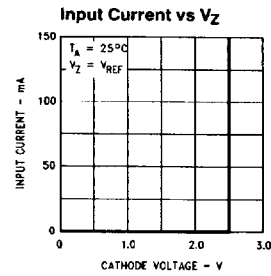
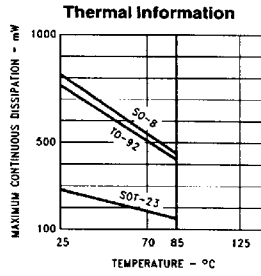
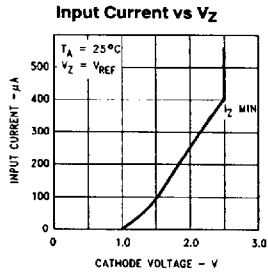

TL/H/10055-8

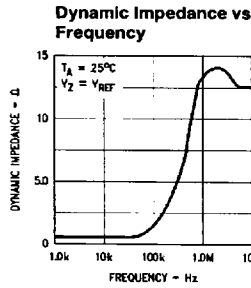

TL/H/10055-9

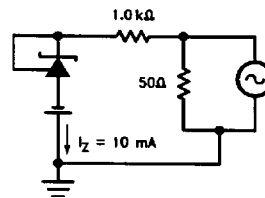

TL/H/10055-10

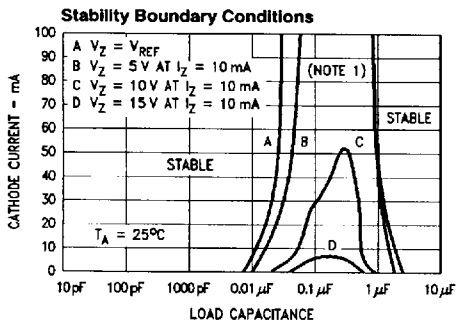

TL/H/10055-11

Note 1: The areas under the curves represent conditions that may cause the device to oscillate. For curves B, C, and D,  $R_2$  and  $V^+$  were adjusted to establish the initial  $V_Z$  and  $I_Z$  conditions with  $C_L = 0$ .  $V^+$  and  $C_L$  were then adjusted to determine the ranges of stability.

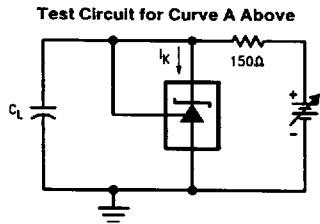

TL/H/10055-12

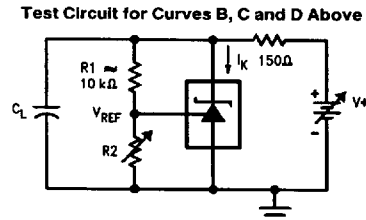

TL/H/10055-13

## Typical Applications

Shunt Regulator

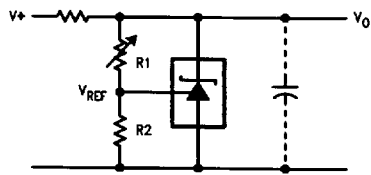

TL/H/10055-14

$$V_O \approx \left(1 + \frac{R_1}{R_2}\right) V_{REF}$$

Series Regulator

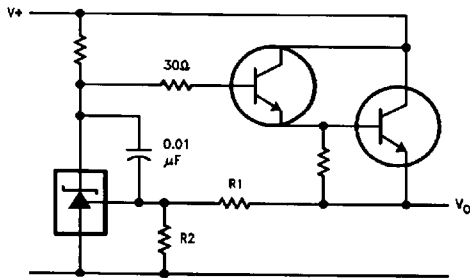

TL/H/10055-16

$$V_O \approx \left(1 + \frac{R_1}{R_2}\right) V_{REF}$$

Single Supply Comparator with Temperature Compensated Threshold

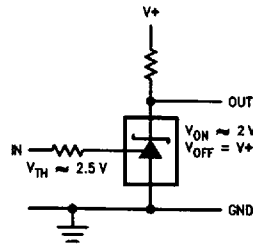

TL/H/10055-15

Output Control of a Three Terminal Fixed Regulator

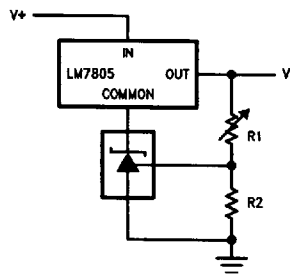

TL/H/10055-17

$$V_O = \left(1 + \frac{R_1}{R_2}\right) V_{REF}$$

$$V_{O \text{ MIN}} = V_{REF} + 5V$$

**Typical Applications (Continued)**

**Higher Current Shunt Regulator**

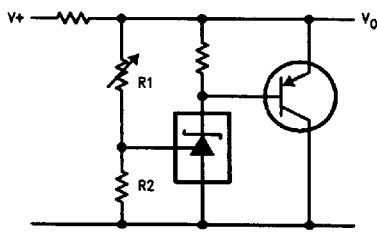

TL/H/10055-18

$$V_O = \left(1 + \frac{R_1}{R_2}\right) V_{REF}$$

**Crow Bar**

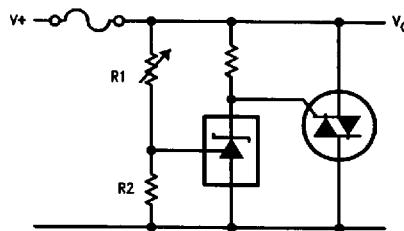

TL/H/10055-19

$$V_{LIMIT} \approx \left(1 + \frac{R_1}{R_2}\right) V_{REF}$$

**Over Voltage/Under Voltage Protection Circuit**

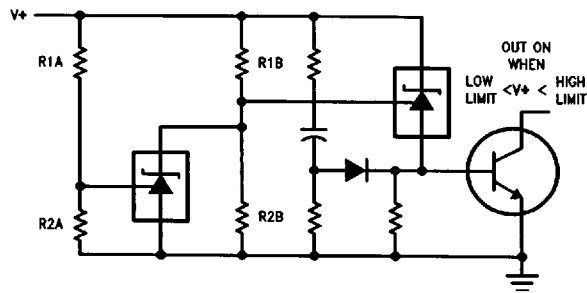

TL/H/10055-20

$$LOW\ LIMIT \approx V_{REF} \left(1 + \frac{R_{1B}}{R_{2B}}\right) + V_{BE}$$

$$HIGH\ LIMIT \approx V_{REF} \left(1 + \frac{R_{1A}}{R_{2A}}\right)$$

**Voltage Monitor**

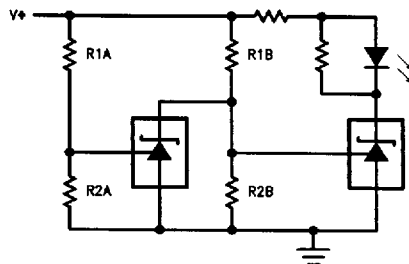

TL/H/10055-21

$$LOW\ LIMIT \approx V_{REF} \left(1 + \frac{R_{1B}}{R_{2B}}\right) \quad LED\ ON\ WHEN\ LOW\ LIMIT < V^+ < HIGH\ LIMIT$$

$$HIGH\ LIMIT \approx V_{REF} \left(1 + \frac{R_{1A}}{R_{2A}}\right)$$

**Typical Applications (Continued)**

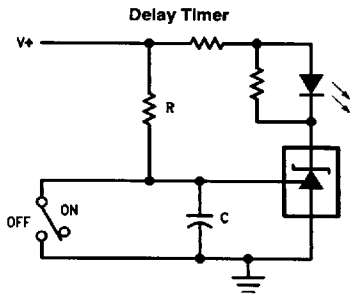

TL/H/10055-22

$$\text{DELAY} = R \cdot C \cdot \ln \frac{V^+}{(V^+) - V_{REF}}$$

$$I_o = \frac{V_{REF}}{R_{CL}}$$

TL/H/10055-23

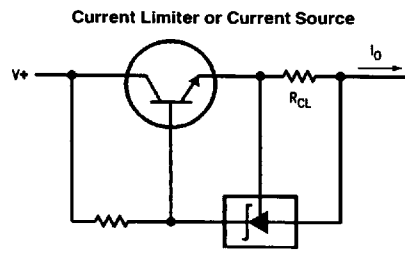

**Constant Current Sink**

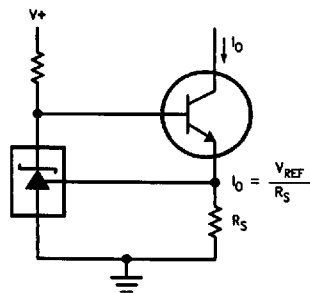

TL/H/10055-24

$$I_o = \frac{V_{REF}}{R_S}$$

**Recommended Solder Pads for SOT-23 Package**

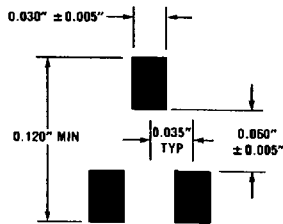

TL/H/10055-27

**TABLE 1. Package Marking for SOT-23**

Order Number	Top Mark
LM431ACM3	N1F
LM431AIM3	N1E
LM431BCM3	N1D
LM431BIM3	N1C
LM431CCM3	N1B
LM431CIM3	N1A



**Physical Dimensions** inches (millimeters) unless otherwise noted

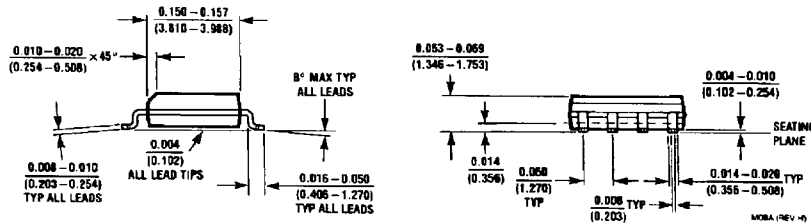
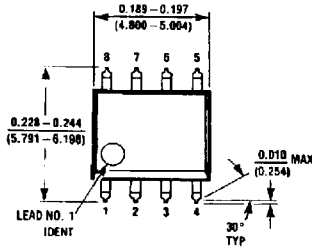

Order Number LM431ACM or LM431AIM  
NS Package Number M08A

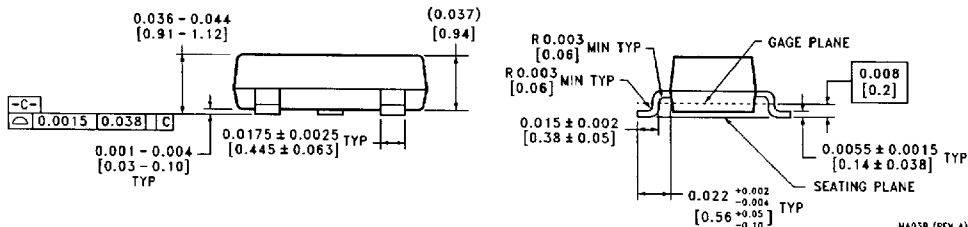
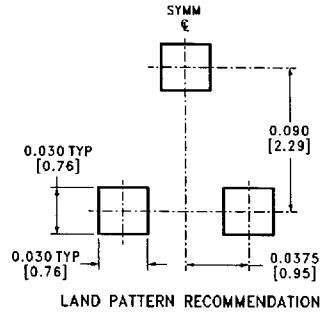
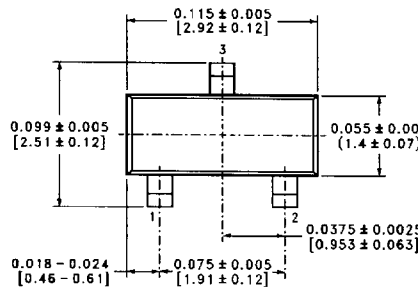

SOT-23 Molded Small Outline Transistor Package (M3)  
Order Number LM60BIM3 or LM60CIM3  
NS Package Number MA03B

**Physical Dimensions** inches (millimeters) unless otherwise noted (Continued)

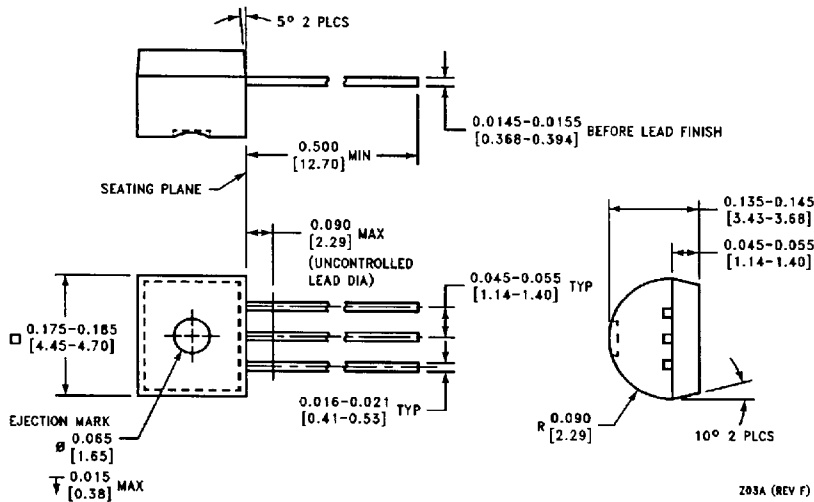

Order Number LM431ACZ or LM431AIZ  
NS Package Number Z03A

Z03A (REV F)

**LIFE SUPPORT POLICY**

NATIONAL'S PRODUCTS ARE NOT AUTHORIZED FOR USE AS CRITICAL COMPONENTS IN LIFE SUPPORT DEVICES OR SYSTEMS WITHOUT THE EXPRESS WRITTEN APPROVAL OF THE PRESIDENT OF NATIONAL SEMICONDUCTOR CORPORATION. As used herein:

1. Life support devices or systems are devices or systems which, (a) are intended for surgical implant into the body, or (b) support or sustain life, and whose failure to perform, when properly used in accordance with instructions for use provided in the labeling, can be reasonably expected to result in a significant injury to the user.
2. A critical component is any component of a life support device or system whose failure to perform can be reasonably expected to cause the failure of the life support device or system, or to affect its safety or effectiveness.



**National Semiconductor Corporation**  
Americas  
Tel: 1(800) 272-9959  
Fax: 1(800) 737-7018  
Email: support@nsc.com

**National Semiconductor Europe**  
Fax: +49 (0) 180-530 85 86  
Email: europe.support@nsc.com  
Deutsch Tel: +49 (0) 180-530 85 85  
English Tel: +49 (0) 180-532 78 32  
Français Tel: +49 (0) 180-532 93 58  
Italiano Tel: +49 (0) 180-534 16 80

**National Semiconductor Southeast Asia**  
Fax: (852) 2376 3901  
Email: sea.support@nsc.com

**National Semiconductor Japan Ltd.**  
Tel: 81-3-5620-7561  
Fax: 81-3-5620-6179

<http://www.national.com>

National does not assume any responsibility for use of any circuitry described, no circuit patent licenses are implied and National reserves the right at any time without notice to change said circuitry and specifications.

6501124 0106047 780