

# MUN5111T1 Series, SMUN5111T1, NSVMUN5111T1 Series



ON Semiconductor®

<http://onsemi.com>

## Bias Resistor Transistors

### PNP Silicon Surface Mount Transistor with Monolithic Bias Resistor Network

This new series of digital transistors is designed to replace a single device and its external resistor bias network. The Bias Resistor Transistor (BRT) contains a single transistor with a monolithic bias network consisting of two resistors; a series base resistor and a base-emitter resistor. The BRT eliminates these individual components by integrating them into a single device. The use of a BRT can reduce both system cost and board space. The device is housed in the SC-70/SOT-323 package which is designed for low power surface mount applications.

#### Features

- Simplifies Circuit Design
- Reduces Board Space
- Reduces Component Count
- The SC-70/SOT-323 package can be soldered using wave or reflow. The modified gull-winged leads absorb thermal stress during soldering eliminating the possibility of damage to the die.
- Available in 8 mm embossed tape and reel – Use the Device Number to order the 7 inch/3000 unit reel. Replace “T1” with “T3” in the Device Number to order the 13 inch/10,000 unit reel.
- S and NSV Prefix for Automotive and Other Applications Requiring Unique Site and Control Change Requirements; AEC-Q101 Qualified and PPAP Capable
- These Devices are Pb-Free, Halogen Free/BFR Free and are RoHS Compliant\*

#### MAXIMUM RATINGS (T<sub>A</sub> = 25°C unless otherwise noted)

Rating	Symbol	Value	Unit
Collector-Base Voltage	V <sub>CBO</sub>	50	Vdc
Collector-Emitter Voltage	V <sub>CEO</sub>	50	Vdc
Collector Current	I <sub>C</sub>	100	mAdc

Stresses exceeding Maximum Ratings may damage the device. Maximum Ratings are stress ratings only. Functional operation above the Recommended Operating Conditions is not implied. Extended exposure to stresses above the Recommended Operating Conditions may affect device reliability.

### PNP SILICON BIAS RESISTOR TRANSISTORS

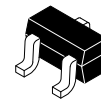

SC-70/SOT-323  
CASE 419  
STYLE 3

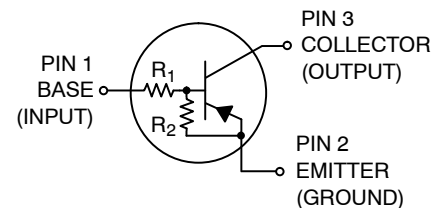

#### MARKING DIAGRAM

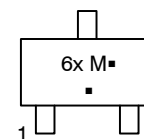

- 6x = Device Code
- M = Date Code\*
- = Pb-Free Package

(Note: Microdot may be in either location)  
\*Date Code orientation may vary depending upon manufacturing location.

#### ORDERING INFORMATION

See specific ordering and shipping information in the package dimensions section on page 2 of this data sheet.

\*For additional information on our Pb-Free strategy and soldering details, please download the ON Semiconductor Soldering and Mounting Techniques Reference Manual, SOLDERRM/D.

# MUN5111T1 Series, SMUN5111T1, NSVMUN5111T1 Series

## THERMAL CHARACTERISTICS

Characteristic	Symbol	Max	Unit
Total Device Dissipation $T_A = 25^\circ\text{C}$  Derate above $25^\circ\text{C}$	$P_D$	202 (Note 1) 310 (Note 2) 1.6 (Note 1) 2.5 (Note 2)	mW  $^\circ\text{C/W}$
Thermal Resistance, Junction-to-Ambient	$R_{\theta JA}$	618 (Note 1) 403 (Note 2)	$^\circ\text{C/W}$
Thermal Resistance, Junction-to-Lead	$R_{\theta JL}$	280 (Note 1) 332 (Note 2)	$^\circ\text{C/W}$
Junction and Storage Temperature Range	$T_J, T_{stg}$	-55 to +150	$^\circ\text{C}$

- FR-4 @ Minimum Pad
- FR-4 @ 1.0 x 1.0 inch Pad

## ORDERING INFORMATION AND RESISTOR VALUES

Device	Package	Marking	R1 (K)	R2 (K)	Shipping†
MUN5111T1G, SMUN5111T1G	SC-70/SOT-323 (Pb-Free)	6A	10	10	3,000/Tape & Reel
MUN5112T1G, SMUN5112T1G	SC-70/SOT-323 (Pb-Free)	6B	22	22	3,000/Tape & Reel
MUN5113T1G, SMUN5113T1G	SC-70/SOT-323 (Pb-Free)	6C	47	47	3,000/Tape & Reel
MUN5113T3G	SC-70/SOT-323 (Pb-Free)	6C	47	47	10,000/Tape & Reel
MUN5113T1G	SC-70/SOT-323 (Pb-Free)	6C	47	47	3,000/Tape & Reel
MUN5114T1G, SMUN5114T1G	SC-70/SOT-323 (Pb-Free)	6D	10	47	3,000/Tape & Reel
MUN5115T1G (Note 3)	SC-70/SOT-323 (Pb-Free)	6E	10	$\infty$	3,000/Tape & Reel
MUN5116T1G (Note 3)	SC-70/SOT-323 (Pb-Free)	6F	4.7	$\infty$	3,000/Tape & Reel
MUN5130T1G (Note 3)	SC-70/SOT-323 (Pb-Free)	6G	1.0	1.0	3,000/Tape & Reel
MUN5131T1G (Note 3)	SC-70/SOT-323 (Pb-Free)	6H	2.2	2.2	3,000/Tape & Reel
MUN5132T1G, NSVMUN5132T1G (Note 3)	SC-70/SOT-323 (Pb-Free)	6J	4.7	4.7	3,000/Tape & Reel
MUN5133T1G, SMUN5133T1G (Note 3)	SC-70/SOT-323 (Pb-Free)	6K	4.7	47	3,000/Tape & Reel
MUN5134T1G (Note 3)	SC-70/SOT-323 (Pb-Free)	6L	22	47	3,000/Tape & Reel
MUN5135T1G (Note 3)	SC-70/SOT-323 (Pb-Free)	6M	2.2	47	3,000/Tape & Reel
MUN5136T1G	SC-70/SOT-323 (Pb-Free)	6N	100	100	3,000/Tape & Reel
MUN5137T1G	SC-70/SOT-323 (Pb-Free)	6P	47	22	3,000/Tape & Reel

†For information on tape and reel specifications, including part orientation and tape sizes, please refer to our Tape and Reel Packaging Specifications Brochure, BRD8011/D.

- New devices. Updated curves to follow in subsequent data sheets.

# MUN5111T1 Series, SMUN5111T1, NSVMUN5111T1 Series

## ELECTRICAL CHARACTERISTICS (T<sub>A</sub> = 25°C unless otherwise noted)

Characteristic	Symbol	Min	Typ	Max	Unit
<b>OFF CHARACTERISTICS</b>					
Collector-Base Cutoff Current (V <sub>CB</sub> = 50 V, I <sub>E</sub> = 0)	I <sub>CBO</sub>	-	-	100	nAdc
Collector-Emitter Cutoff Current (V <sub>CE</sub> = 50 V, I <sub>B</sub> = 0)	I <sub>CEO</sub>	-	-	500	nAdc
Emitter-Base Cutoff Current (V <sub>EB</sub> = 6.0 V, I <sub>C</sub> = 0)	I <sub>EBO</sub>				mAdc
MUN5111T1, SMUN5111T1		-	-	0.5	
MUN5112T1, SMUN5112T1		-	-	0.2	
MUN5113T1, SMUN5113T1		-	-	0.1	
MUN5114T1, SMUN5114T1		-	-	0.2	
MUN5115T1		-	-	0.9	
MUN5116T1		-	-	1.9	
MUN5130T1		-	-	4.3	
MUN5131T1		-	-	2.3	
MUN5132T1, NSVMUN5132T1		-	-	1.5	
MUN5133T1, SMUN5133T1		-	-	0.18	
MUN5134T1		-	-	0.13	
MUN5135T1		-	-	0.2	
MUN5136T1		-	-	0.05	
MUN5137T1		-	-	0.13	
Collector-Base Breakdown Voltage (I <sub>C</sub> = 10 μA, I <sub>E</sub> = 0)	V <sub>(BR)CBO</sub>	50	-	-	Vdc
Collector-Emitter Breakdown Voltage (Note 4) (I <sub>C</sub> = 2.0 mA, I <sub>B</sub> = 0)	V <sub>(BR)CEO</sub>	50	-	-	Vdc

## ON CHARACTERISTICS (Note 4)

DC Current Gain (V <sub>CE</sub> = 10 V, I <sub>C</sub> = 5.0 mA)	h <sub>FE</sub>				
MUN5111T1, SMUN5111T1		35	60	-	
MUN5112T1, SMUN5112T1		60	100	-	
MUN5113T1, SMUN5113T1		80	140	-	
MUN5114T1, SMUN5114T1		80	140	-	
MUN5115T1		160	250	-	
MUN5116T1		160	250	-	
MUN5130T1		3.0	5.0	-	
MUN5131T1		8.0	15	-	
MUN5132T1, NSVMUN5132T1		15	27	-	
MUN5133T1, SMUN5133T1		80	140	-	
MUN5134T1		80	130	-	
MUN5135T1		80	140	-	
MUN5136T1		80	150	-	
MUN5137T1		80	140	-	
Collector-Emitter Saturation Voltage (I <sub>C</sub> = 10 mA, I <sub>E</sub> = 0.3 mA)	V <sub>CE(sat)</sub>				Vdc
MUN5130T1/MUN5131T1		-	-	0.25	
(I <sub>C</sub> = 10 mA, I <sub>B</sub> = 5 mA)					
(I <sub>C</sub> = 10 mA, I <sub>B</sub> = 1 mA)					
MUN5115T1/MUN5116T1/MUN5132T1/NSVMUN5132T1/ MUN5133T1/SMUN5133T1/MUN5134T1		-	-	0.25	
Output Voltage (on) (V <sub>CC</sub> = 5.0 V, V <sub>B</sub> = 2.5 V, R <sub>L</sub> = 1.0 kΩ)	V <sub>OL</sub>				Vdc
MUN5111T1, SMUN5111T1		-	-	0.2	
MUN5112T1, SMUN5112T1		-	-	0.2	
MUN5114T1, SMUN5114T1		-	-	0.2	
MUN5115T1		-	-	0.2	
MUN5116T1		-	-	0.2	
MUN5130T1		-	-	0.2	
MUN5131T1		-	-	0.2	
MUN5132T1, NSVMUN5132T1		-	-	0.2	
MUN5133T1, SMUN5133T1		-	-	0.2	
MUN5134T1		-	-	0.2	
MUN5135T1		-	-	0.2	
(V <sub>CC</sub> = 5.0 V, V <sub>B</sub> = 3.5 V, R <sub>L</sub> = 1.0 kΩ)					
MUN5113T1		-	-	0.2	
(V <sub>CC</sub> = 5.0 V, V <sub>B</sub> = 5.5 V, R <sub>L</sub> = 1.0 kΩ)					
MUN5136T1		-	-	0.2	
(V <sub>CC</sub> = 5.0 V, V <sub>B</sub> = 4.0 V, R <sub>L</sub> = 1.0 kΩ)					
MUN5137T1		-	-	0.2	

4. Pulse Test: Pulse Width < 300 μs, Duty Cycle < 2.0%

# MUN5111T1 Series, SMUN5111T1, NSVMUN5111T1 Series

## ELECTRICAL CHARACTERISTICS (T<sub>A</sub> = 25°C unless otherwise noted) (Continued)

Characteristic	Symbol	Min	Typ	Max	Unit
Output Voltage (off) (V <sub>CC</sub> = 5.0 V, V <sub>B</sub> = 0.5 V, R <sub>L</sub> = 1.0 kΩ) (V <sub>CC</sub> = 5.0 V, V <sub>B</sub> = 0.050 V, R <sub>L</sub> = 1.0 kΩ) MUN5130T1 (V <sub>CC</sub> = 5.0 V, V <sub>B</sub> = 0.25 V, R <sub>L</sub> = 1.0 kΩ) MUN5115T1 MUN5116T1 MUN5131T1 MUN5132T1, NSVMUN5132T1	V <sub>OH</sub>	4.9	–	–	Vdc
Input Resistor MUN5111T1, SMUN5111T1 MUN5112T1, SMUN5112T1 MUN5113T1, SMUN5113T1 MUN5114T1, SMUN5114T1 MUN5115T1 MUN5116T1 MUN5130T1 MUN5131T1 MUN5132T1, NSVMUN5132T1 MUN5133T1, SMUN5133T1 MUN5134T1 MUN5135T1 MUN5136T1 MUN5137T1	R <sub>1</sub>	7.0 15.4 32.9 7.0 7.0 3.3 0.7 1.5 3.3 3.3 15.4 1.54 70 32.9	10 22 47 10 10 4.7 1.0 2.2 4.7 4.7 22 2.2 100 47	13 28.6 61.1 13 13 6.1 1.3 2.9 6.1 6.1 28.6 2.86 130 61.1	kΩ
Resistor Ratio MUN5111T1/SMUN5111T1/MUN5112T1/SMUN5112T1/ MUN5113T1/SMUN5113T1/MUN5136T1 MUN5114T1/SMUN5114T1 MUN5115T1/MUN5116T1 MUN5130T1/MUN5131T1/MUN5132T1/NSVMUN5132T1 MUN5133T1/SMUN5133T1 MUN5134T1 MUN5135T1 MUN5136T1 MUN5137T1	R <sub>1</sub> /R <sub>2</sub>	0.8 0.17 – 0.8 0.055 0.38 0.038 1.7	1.0 0.21 – 1.0 0.1 0.47 0.047 2.1	1.2 0.25 – 1.2 0.185 0.56 0.056 2.6	

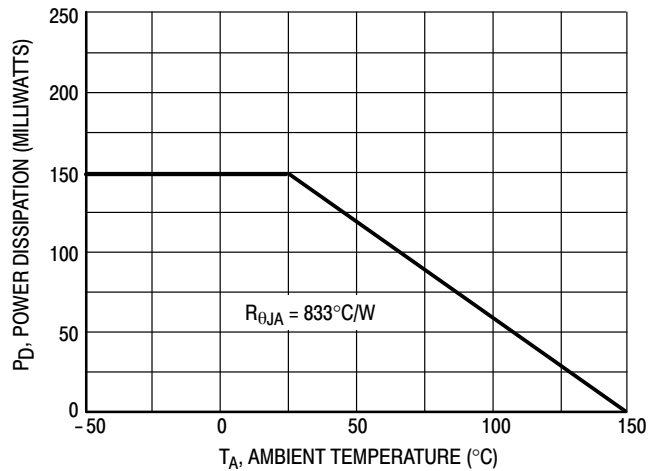

**Figure 1. Derating Curve**

# MUN5111T1 Series, SMUN5111T1, NSVMUN5111T1 Series

## TYPICAL ELECTRICAL CHARACTERISTICS – MUN5111T1G, SMUN5111T1G

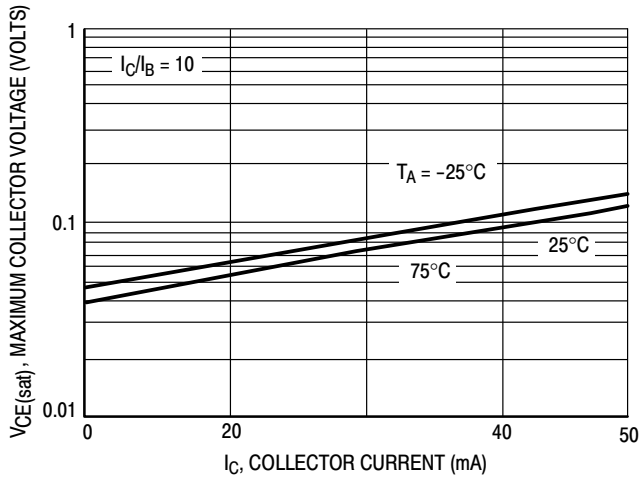

Figure 2.  $V_{CE(sat)}$  versus  $I_C$

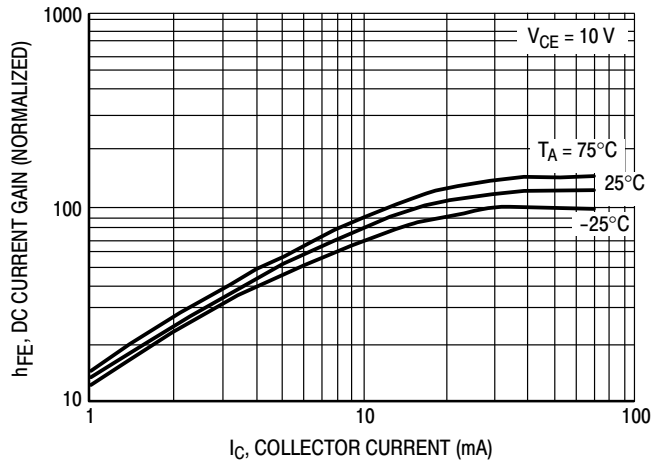

Figure 3. DC Current Gain

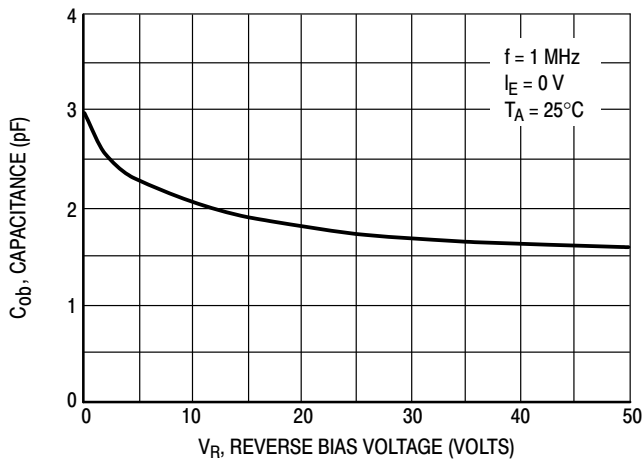

Figure 4. Output Capacitance

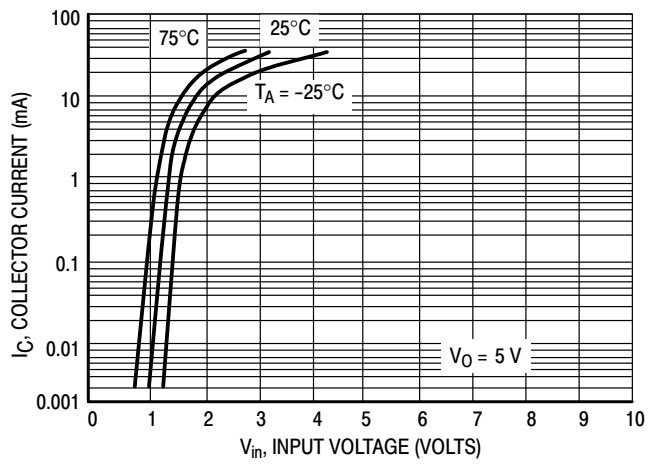

Figure 5. Output Current versus Input Voltage

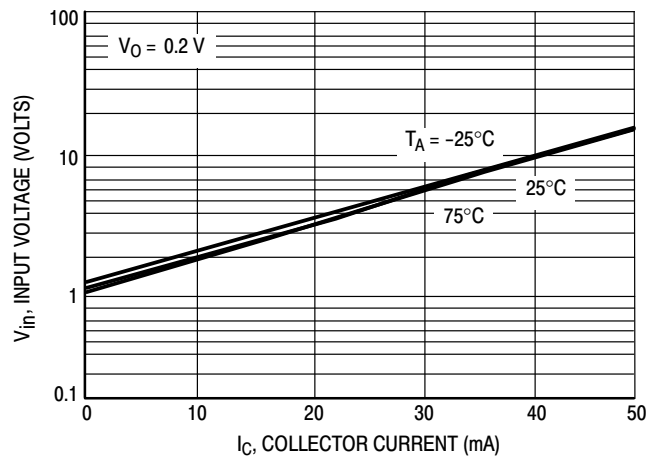

Figure 6. Input Voltage versus Output Current

MUN5111T1 Series, SMUN5111T1, NSVMUN5111T1 Series

TYPICAL ELECTRICAL CHARACTERISTICS – MUN5112T1G, SMUN5112T1G

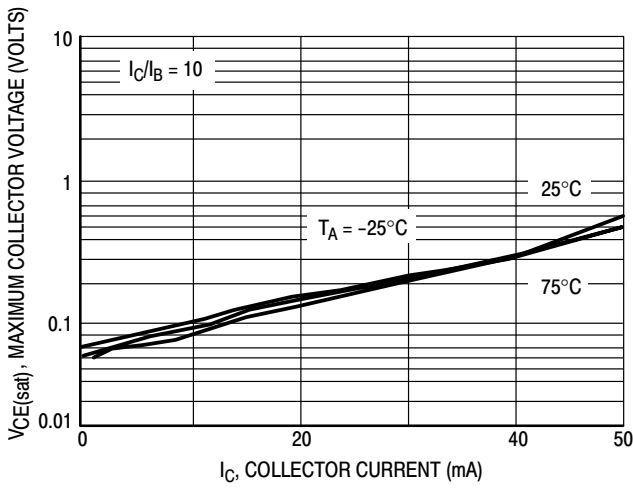

Figure 7.  $V_{CE(sat)}$  versus  $I_C$

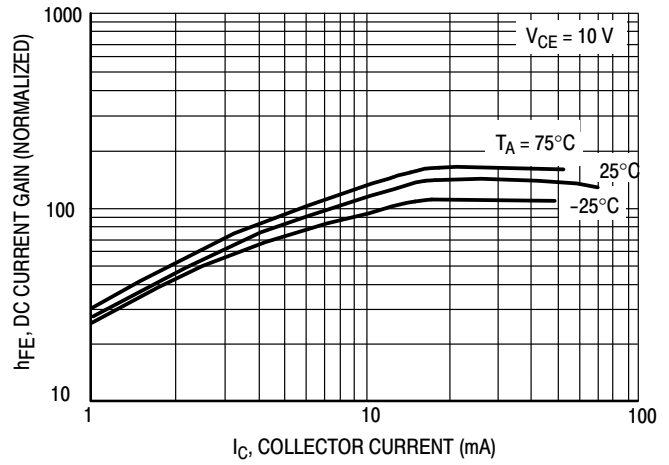

Figure 8. DC Current Gain

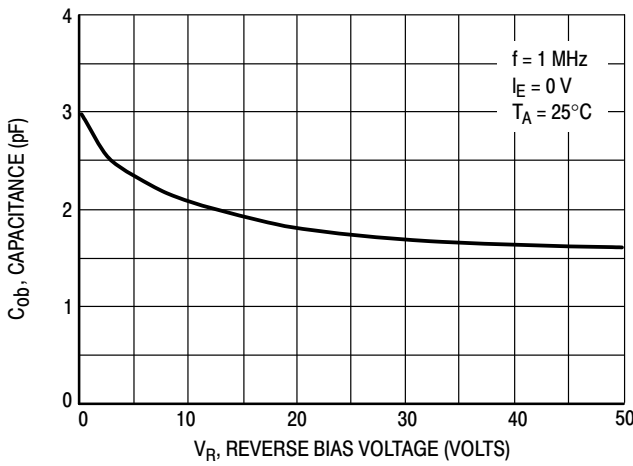

Figure 9. Output Capacitance

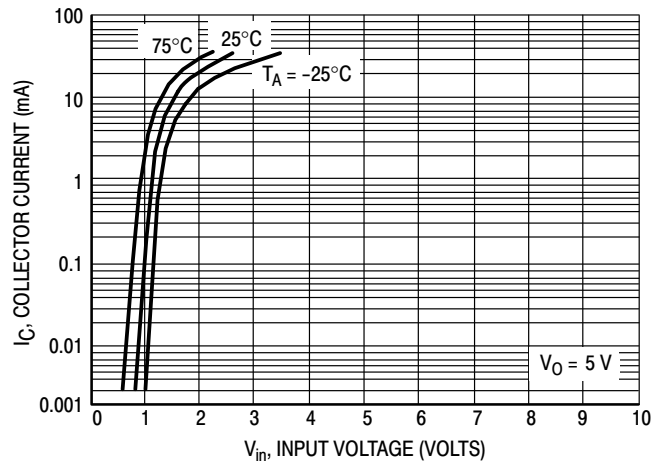

Figure 10. Output Current versus Input Voltage

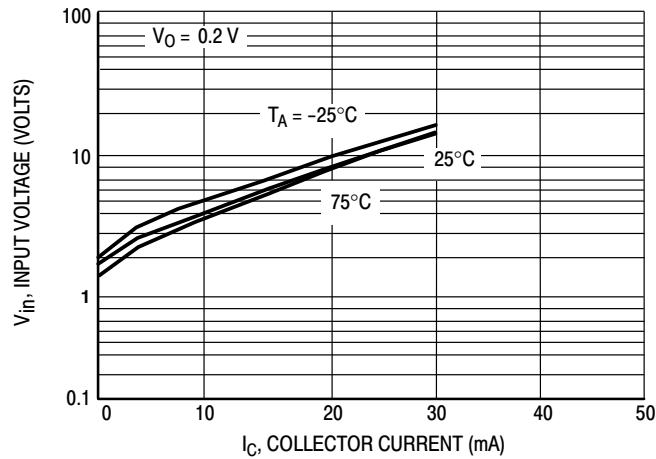

Figure 11. Input Voltage versus Output Current

MUN5111T1 Series, SMUN5111T1, NSVMUN5111T1 Series

TYPICAL ELECTRICAL CHARACTERISTICS – MUN5113T1G, SMUN5113T1G

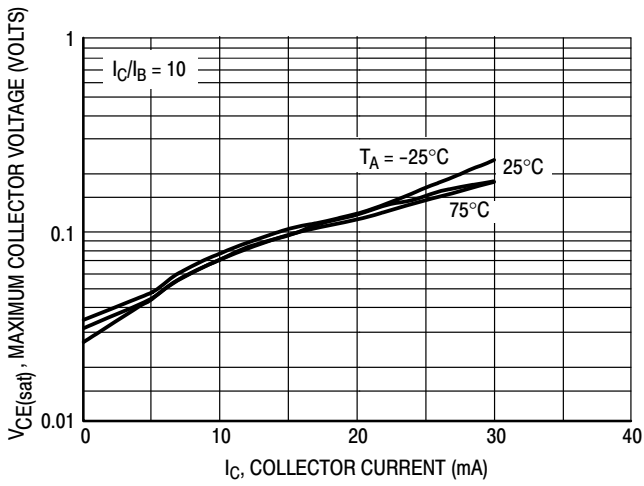

Figure 12.  $V_{CE(sat)}$  versus  $I_C$

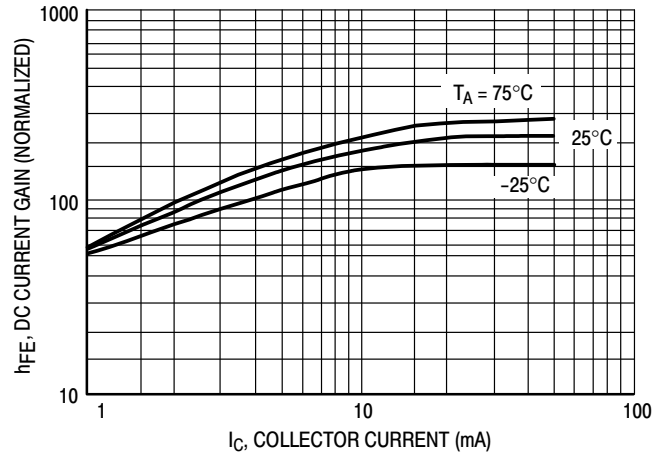

Figure 13. DC Current Gain

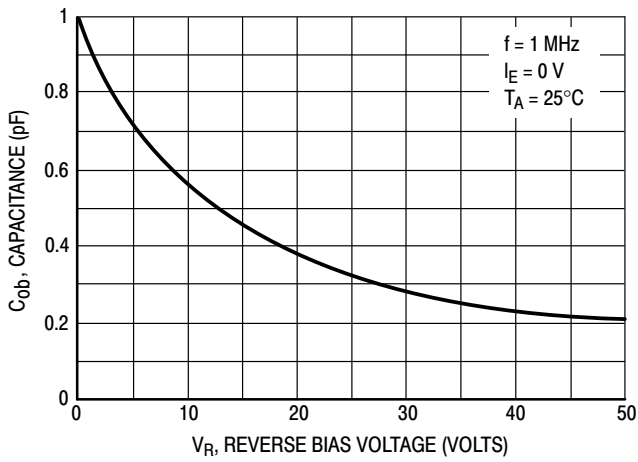

Figure 14. Output Capacitance

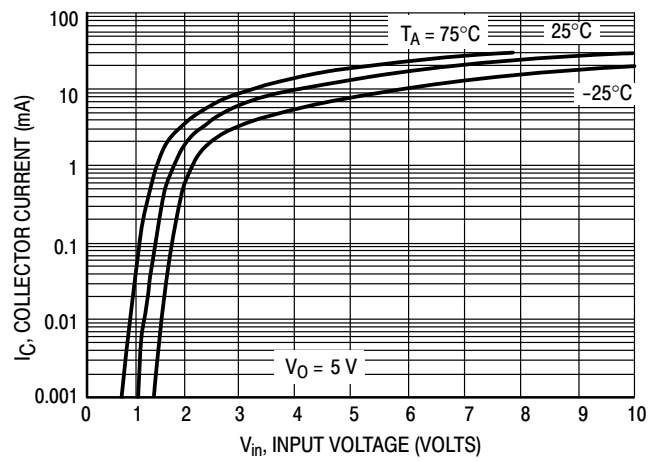

Figure 15. Output Current versus Input Voltage

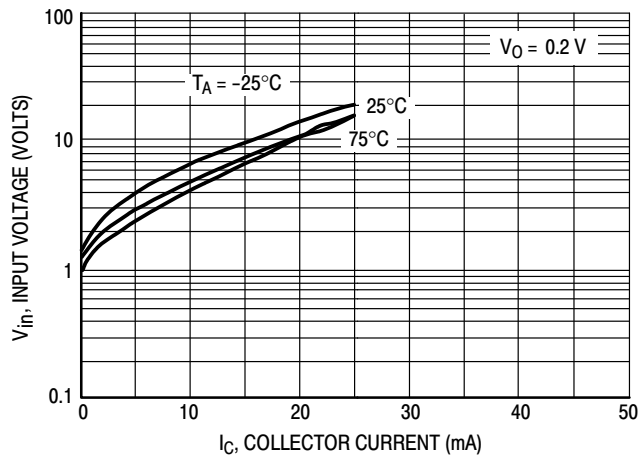

Figure 16. Input Voltage versus Output Current

# MUN5111T1 Series, SMUN5111T1, NSVMUN5111T1 Series

## TYPICAL ELECTRICAL CHARACTERISTICS – MUN5114T1G, SMUN5114T1G

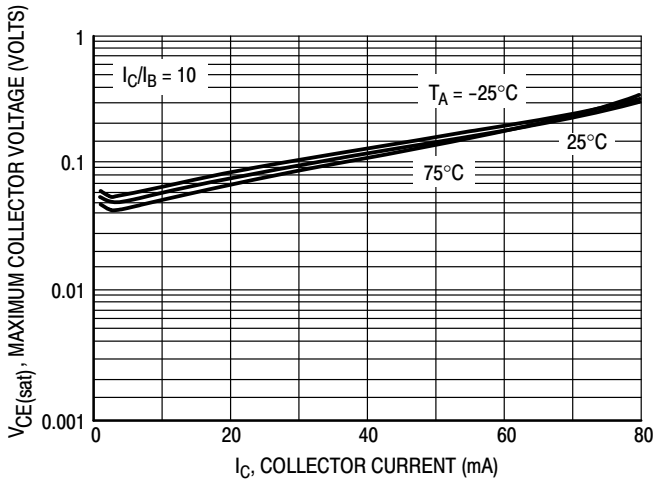

Figure 17.  $V_{CE(sat)}$  versus  $I_C$

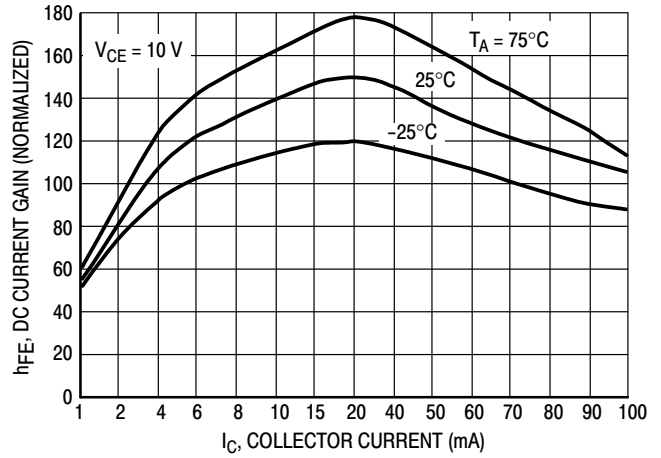

Figure 18. DC Current Gain

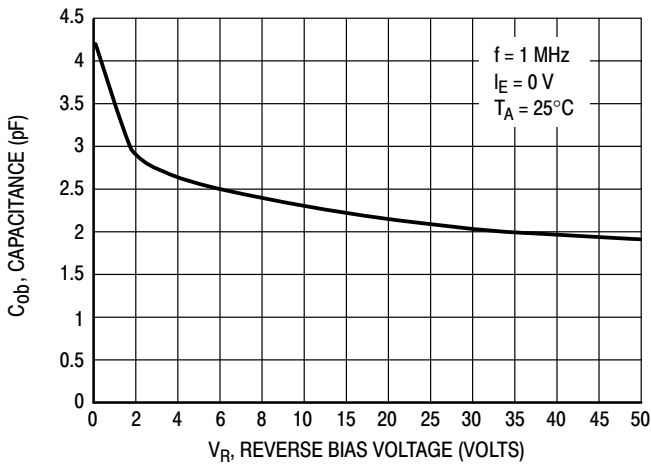

Figure 19. Output Capacitance

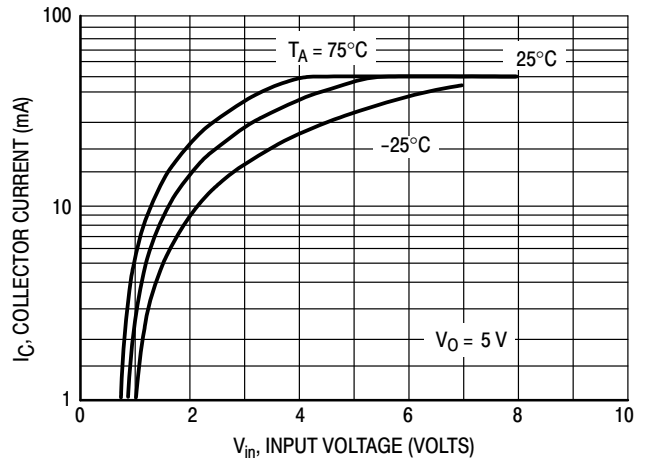

Figure 20. Output Current versus Input Voltage

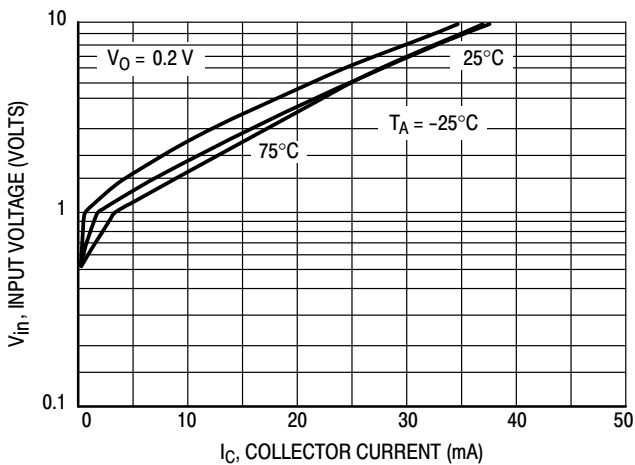

Figure 21. Input Voltage versus Output Current

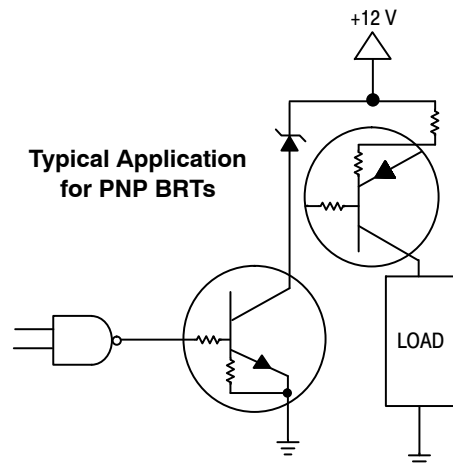

Figure 22. Inexpensive, Unregulated Current Source



MUN5111T1 Series, SMUN5111T1, NSVMUN5111T1 Series

TYPICAL ELECTRICAL CHARACTERISTICS — MUN5132T1G, NSVMUN5132T1G

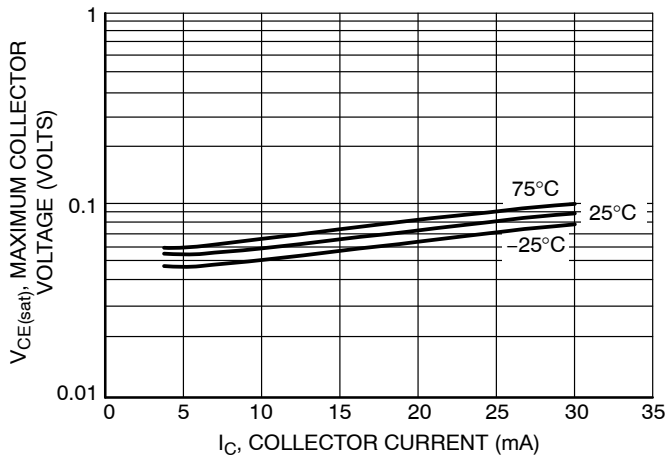

Figure 23. Maximum Collector Voltage versus Collector Current

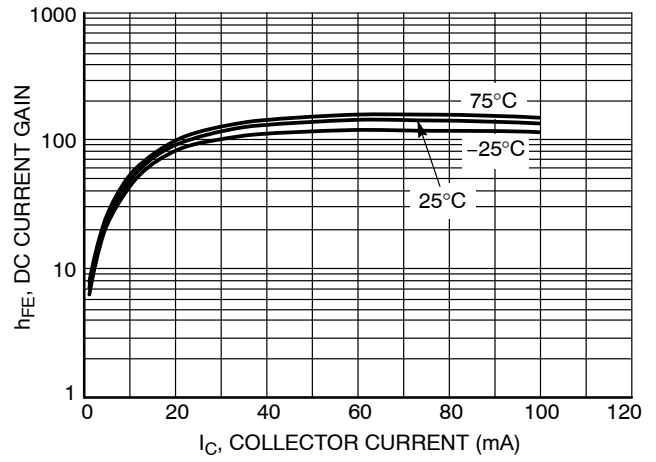

Figure 24. DC Current Gain

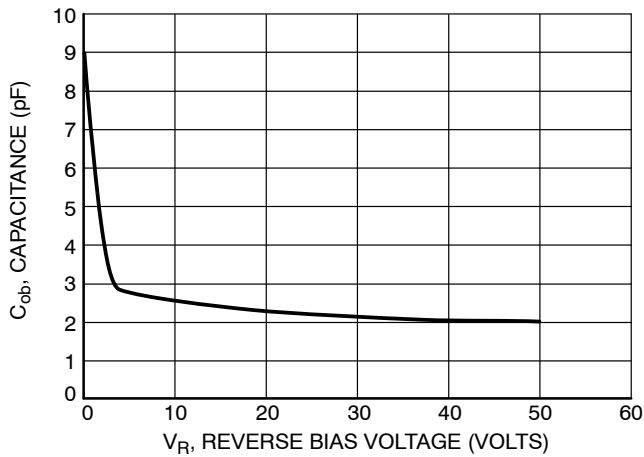

Figure 25. Output Capacitance

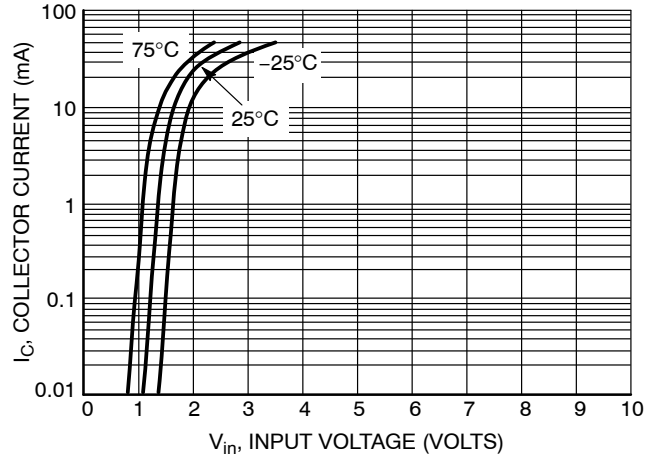

Figure 26. Output Current versus Input Voltage

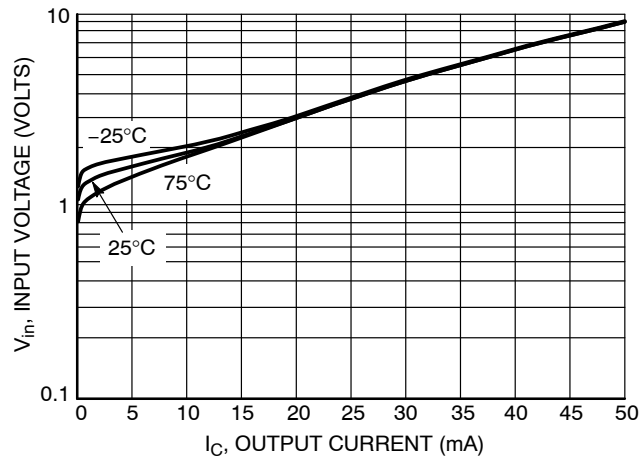

Figure 27. Input Voltage versus Output Current

MUN5111T1 Series, SMUN5111T1, NSVMUN5111T1 Series

TYPICAL ELECTRICAL CHARACTERISTICS — MUN5133T1G, SMUN5133T1G

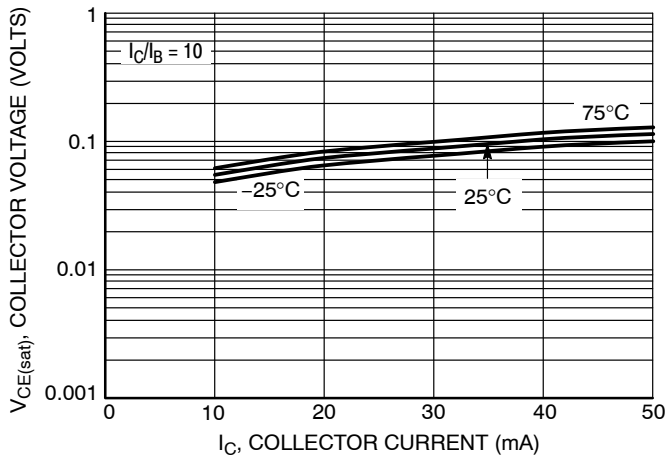

Figure 28.  $V_{CE(sat)}$  versus  $I_C$

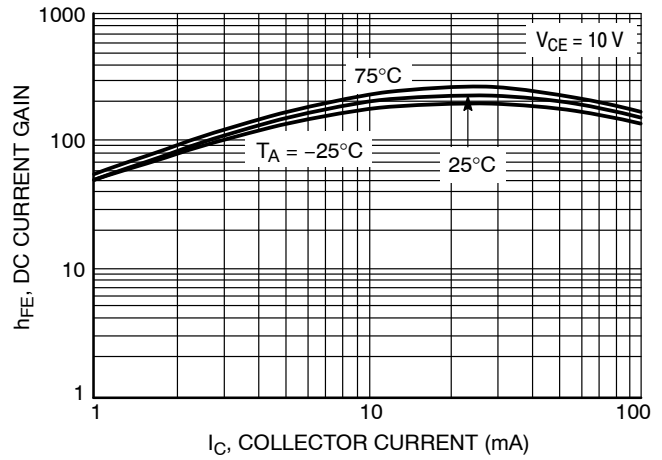

Figure 29. DC Current Gain

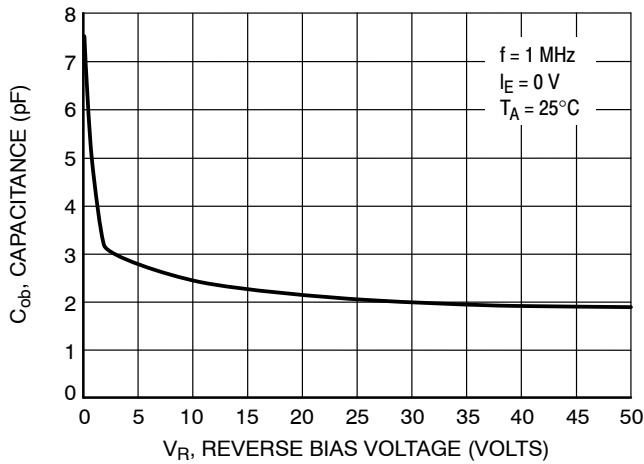

Figure 30. Output Capacitance

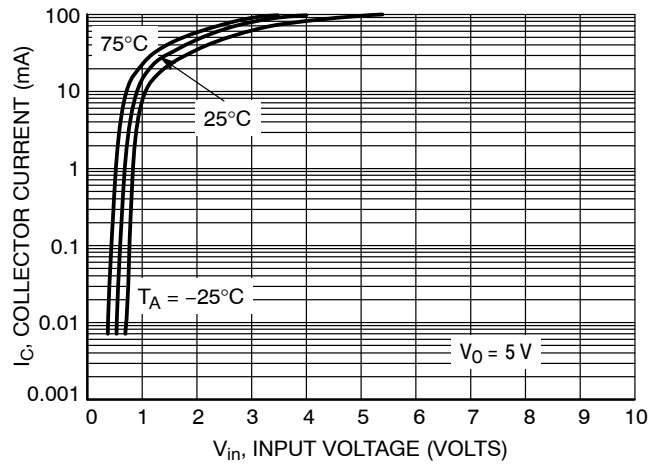

Figure 31. Output Current versus Input Voltage

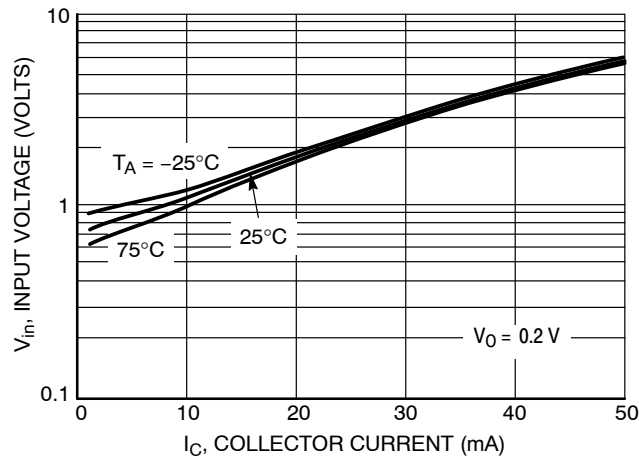

Figure 32. Input Voltage versus Output Current

TYPICAL ELECTRICAL CHARACTERISTICS — MUN5135T1G

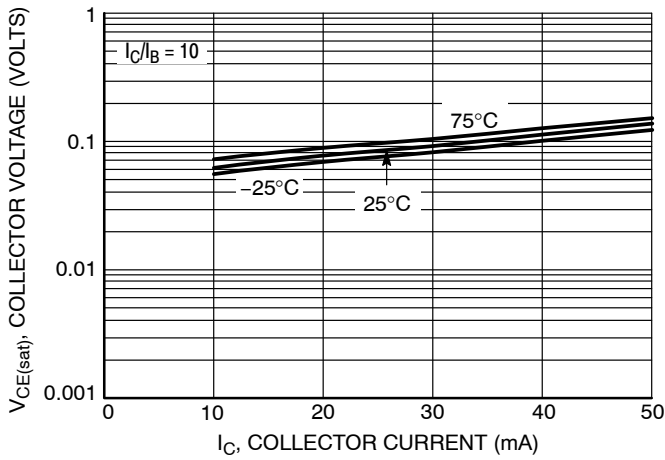

Figure 33.  $V_{CE(sat)}$  versus  $I_C$

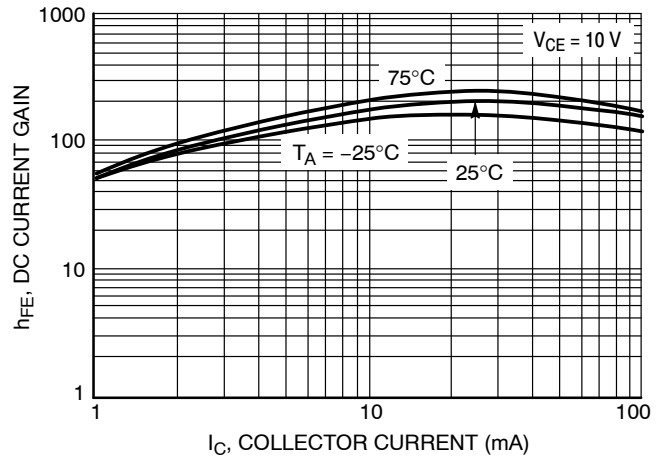

Figure 34. DC Current Gain

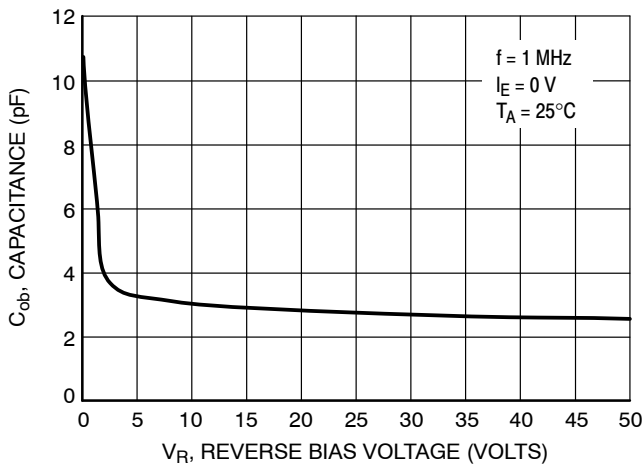

Figure 35. Output Capacitance

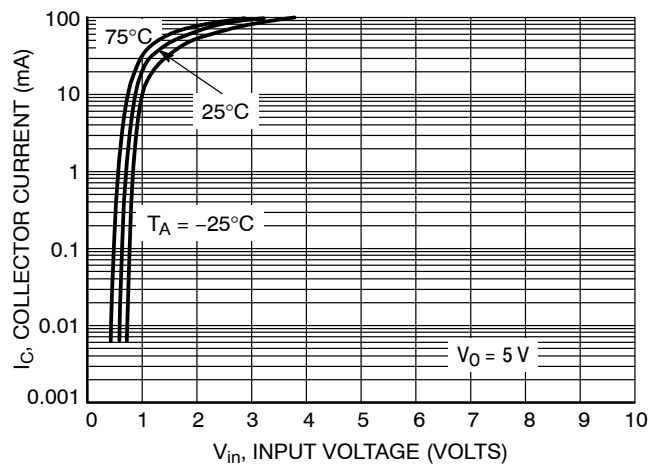

Figure 36. Output Current versus Input Voltage

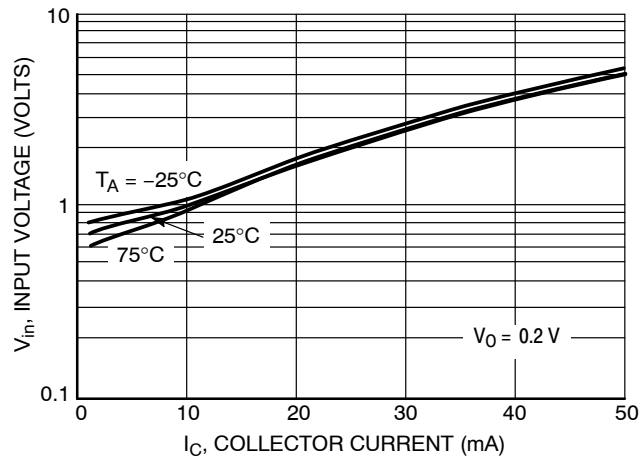

Figure 37. Input Voltage versus Output Current

TYPICAL ELECTRICAL CHARACTERISTICS — MUN5136T1G

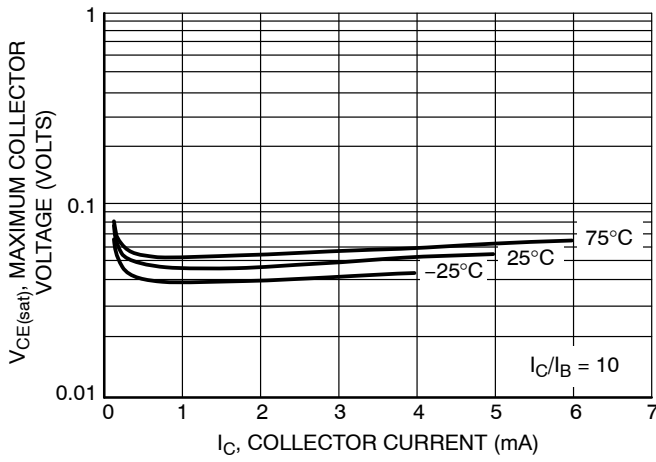

Figure 38. Maximum Collector Voltage versus Collector Current

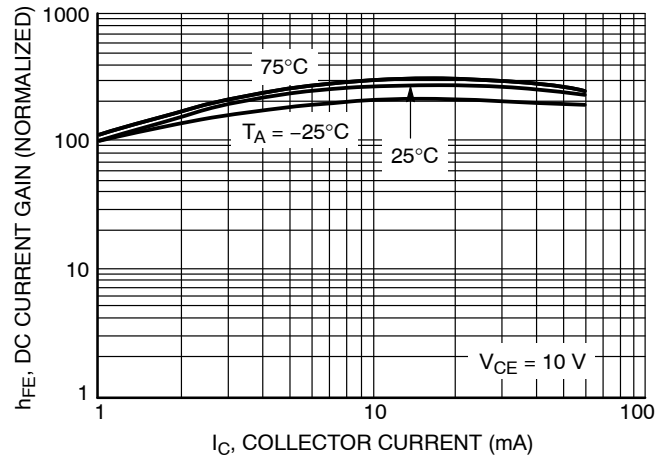

Figure 39. DC Current Gain

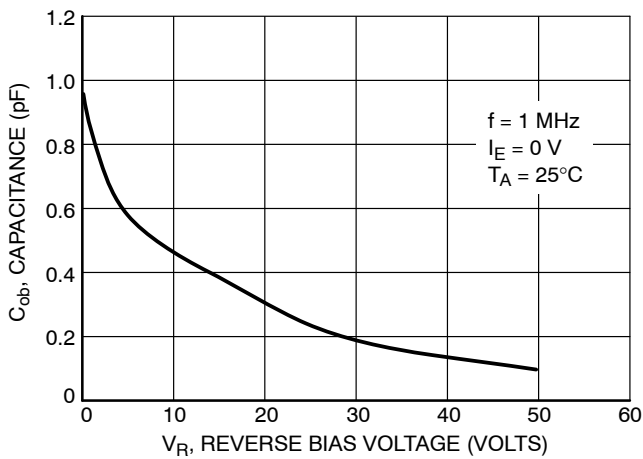

Figure 40. Output Capacitance

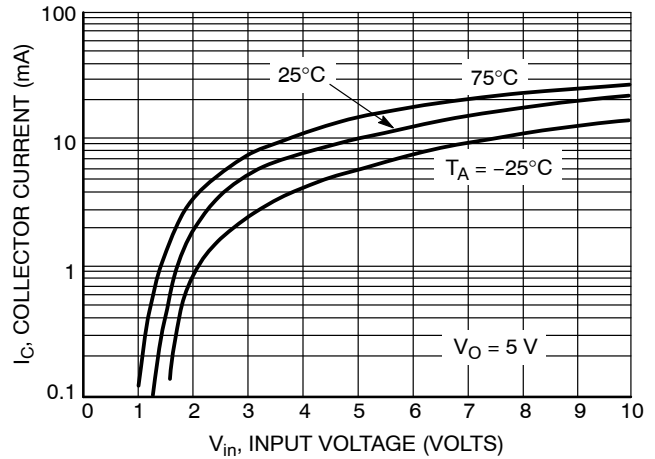

Figure 41. Output Current versus Input Voltage

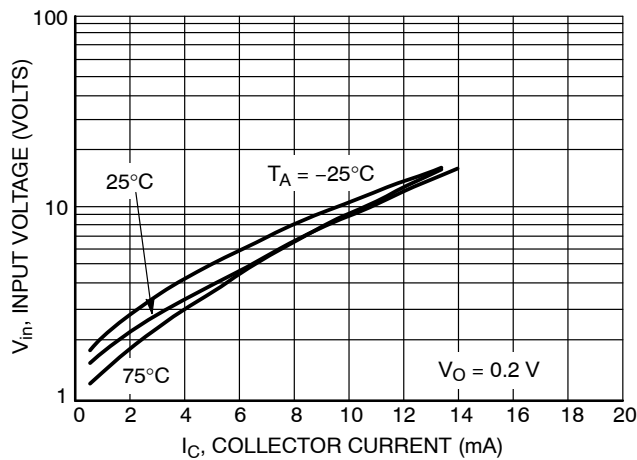

Figure 42. Input Voltage versus Output Current

TYPICAL ELECTRICAL CHARACTERISTICS — MUN5137T1G

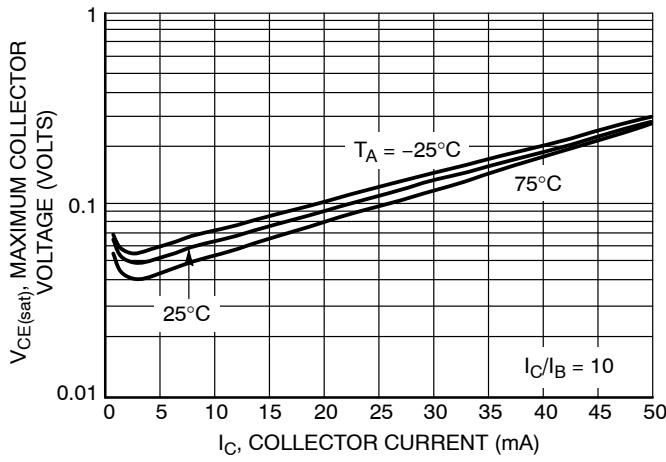

Figure 43. Maximum Collector Voltage versus Collector Current

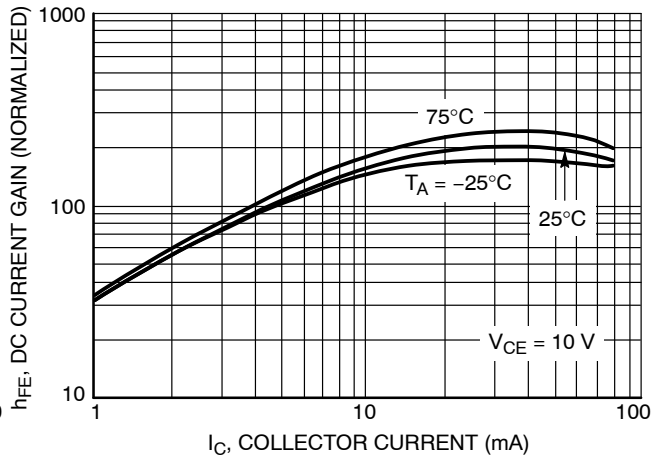

Figure 44. DC Current Gain

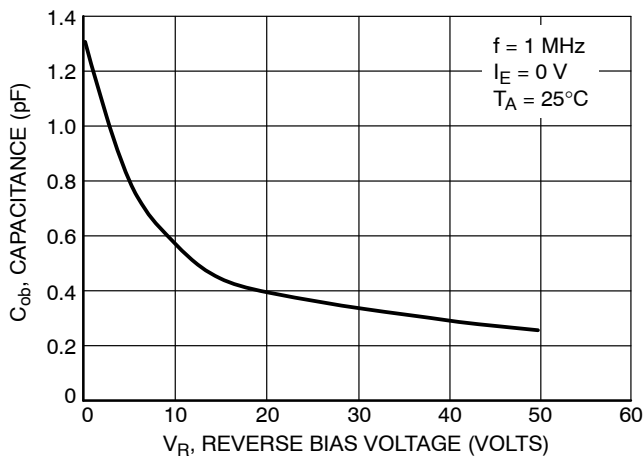

Figure 45. Output Capacitance

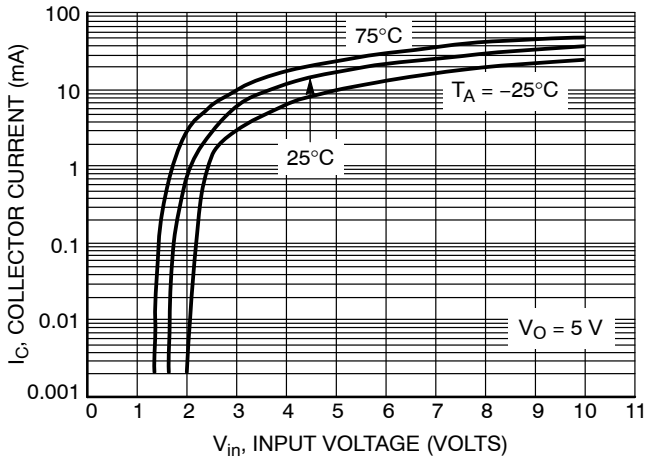

Figure 46. Output Current versus Input Voltage

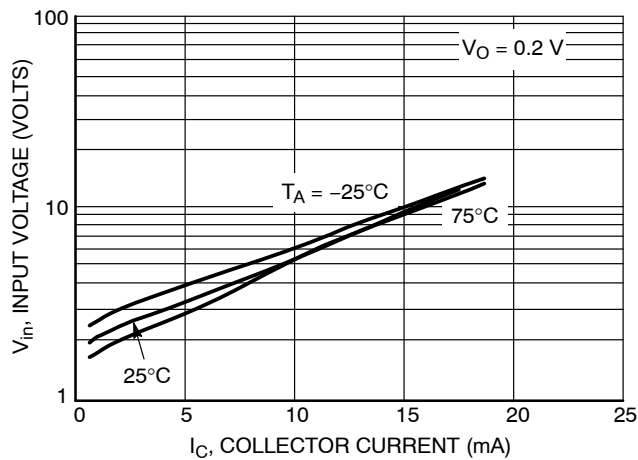
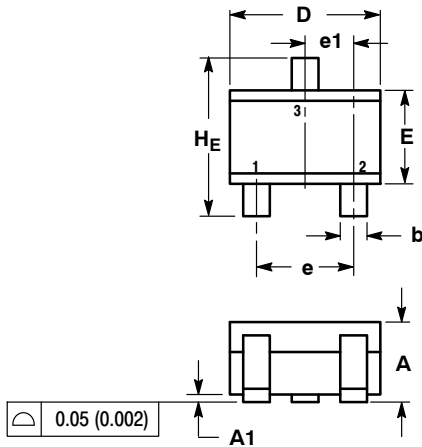

Figure 47. Input Voltage versus Output Current

# MUN5111T1 Series, SMUN5111T1, NSVMUN5111T1 Series

## PACKAGE DIMENSIONS

SC-70/SOT-323  
CASE 419-04  
ISSUE N



- NOTES:  
1. DIMENSIONING AND TOLERANCING PER ANSI Y14.5M, 1982.  
2. CONTROLLING DIMENSION: INCH.

DIM	MILLIMETERS			INCHES		
	MIN	NOM	MAX	MIN	NOM	MAX
A	0.80	0.90	1.00	0.032	0.035	0.040
A1	0.00	0.05	0.10	0.000	0.002	0.004
A2	0.70 REF			0.028 REF		
b	0.30	0.35	0.40	0.012	0.014	0.016
c	0.10	0.18	0.25	0.004	0.007	0.010
D	1.80	2.10	2.20	0.071	0.083	0.087
E	1.15	1.24	1.35	0.045	0.049	0.053
e	1.20	1.30	1.40	0.047	0.051	0.055
e1	0.65 BSC			0.026 BSC		
L	0.20	0.38	0.56	0.008	0.015	0.022
HE	2.00	2.10	2.40	0.079	0.083	0.095

STYLE 3:  
PIN 1. BASE  
2. EMITTER  
3. COLLECTOR

### SOLDERING FOOTPRINT\*

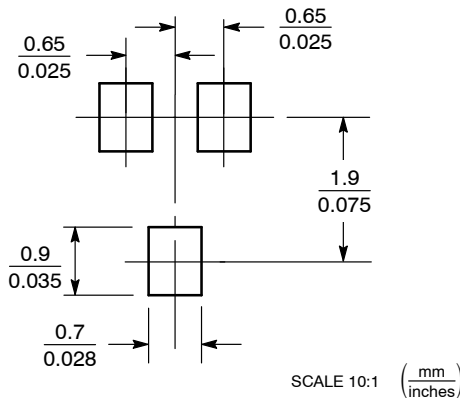

\*For additional information on our Pb-Free strategy and soldering details, please download the ON Semiconductor Soldering and Mounting Techniques Reference Manual, SOLDERRM/D.

ON Semiconductor and are registered trademarks of Semiconductor Components Industries, LLC (SCILLC). SCILLC reserves the right to make changes without further notice to any products herein. SCILLC makes no warranty, representation or guarantee regarding the suitability of its products for any particular purpose, nor does SCILLC assume any liability arising out of the application or use of any product or circuit, and specifically disclaims any and all liability, including without limitation special, consequential or incidental damages. "Typical" parameters which may be provided in SCILLC data sheets and/or specifications can and do vary in different applications and actual performance may vary over time. All operating parameters, including "Typicals" must be validated for each customer application by customer's technical experts. SCILLC does not convey any license under its patent rights nor the rights of others. SCILLC products are not designed, intended, or authorized for use as components in systems intended for surgical implant into the body, or other applications intended to support or sustain life, or for any other application in which the failure of the SCILLC product could create a situation where personal injury or death may occur. Should Buyer purchase or use SCILLC products for any such unintended or unauthorized application, Buyer shall indemnify and hold SCILLC and its officers, employees, subsidiaries, affiliates, and distributors harmless against all claims, costs, damages, and expenses, and reasonable attorney fees arising out of, directly or indirectly, any claim of personal injury or death associated with such unintended or unauthorized use, even if such claim alleges that SCILLC was negligent regarding the design or manufacture of the part. SCILLC is an Equal Opportunity/Affirmative Action Employer. This literature is subject to all applicable copyright laws and is not for resale in any manner.

### PUBLICATION ORDERING INFORMATION

**LITERATURE FULFILLMENT:**  
Literature Distribution Center for ON Semiconductor  
P.O. Box 5163, Denver, Colorado 80217 USA  
**Phone:** 303-675-2175 or 800-344-3860 Toll Free USA/Canada  
**Fax:** 303-675-2176 or 800-344-3867 Toll Free USA/Canada  
**Email:** orderlit@onsemi.com

**N. American Technical Support:** 800-282-9855 Toll Free  
USA/Canada  
**Europe, Middle East and Africa Technical Support:**  
Phone: 421 33 790 2910  
**Japan Customer Focus Center**  
Phone: 81-3-5817-1050

**ON Semiconductor Website:** [www.onsemi.com](http://www.onsemi.com)  
**Order Literature:** <http://www.onsemi.com/orderlit>

For additional information, please contact your local Sales Representative